



# MANUEL D'INSTRUCTIONS

## INSTRUCTION MANUAL

---

### **SOLARIUM FLORENCE 10X12**

FLORENCE SOLARIUM 10X12

---

sku: W1209-12		
sku: W1209-32		

**NE DÉTRUISEZ PAS LES BOÎTES AVANT QUE L'ABRI SOIT COMPLÈTEMENT ASSEMBLÉ  
POUR LA RÉFÉRENCE FUTURE, PRENEZ DES PHOTOS DE TOUS LES SIX COTÉS DE CHACUNES  
DES BOÎTES À LA RÉCEPTION DU PRODUIT.**

**VEUILLEZ VÉRIFIER LE CONTENU DE CHAQUE BOÎTE A L'AIDE DE LA LISTE DES PIÈCES**

## **LES INSTRUCTIONS D'INSTALLATION IMPORTANTE: RETENIR POUR LA FUTURE RÉFÉRENCE, LIRE ATTENTIVEMENT**

Consultez votre autorité locale / les codes municipaux locaux concernant l'installation de structures temporaires avant l'achat ou l'assemblage. Certaines juridictions peuvent exiger des permis pour, ou réglementer autrement, l'installation et l'utilisation.

Pour l'assistance de l'assemblage, d'installation, des pièces en particulier, ou service à la clientèle, veuillez contacter Gazebo Penguin au numéro de téléphone mentionné mi-bas : (français, anglais, lun. à ven. de 8 du matin à 4 après-midi est) :

**Montréal: (514) 276-3485**

**Canada et États-Unis: 1-800-737-7174**

### ATTENTION:

- Pour une utilisation à l'extérieur.
- La neige doit être nettoyée en tout temps, ne pas laisser s'accumuler.
- Conserver votre **preuve d'achat** pour la garantie. Veuillez **garder les boîtes** jusqu'à la fin de l'installation.
- D'assemblage peut durer plus que 4 heures et l'exige d'avoir au moins 3 personnes.



### AVANT ASSEMBLAGE:

- Veuillez ne pas détruire les boîtes avant d'avoir terminé l'assemblage.
- La fondation doit être sous le niveau de sol, plat et solide, comme du béton ou de l'asphalte.
- Tenez à l'écart des lignes électriques aériennes, des branches d'arbres et d'autres structures.
- Vérifiez s'il y a des tuyaux ou des fils souterrains si le creusement ou le forage est nécessaire.
- Ne pas installer à proximité des lignes de toit ou d'autres structures qui pourraient jeter de la neige, de la glace ou une pluie excessive sur le toit.
- Assemblez la structure près du point final d'utilisation la plus proche possible.
- Il est recommandé de porter des gants de sécurité, des lunettes de sécurité et des casques de protection pour l'installation.
- Ne vous suspendez pas, ne grimpez pas et ne vous tenez pas debout sur la structure ou le toit.
- Avant le montage, lisez les instructions et vérifiez que toutes les pièces sont présentes dans les boîtes. S'il manque des pièces, svp, contactez notre département de garantie.
- Un escabeau de 6 pieds (1,8 m), un tournevis Phillips, un ruban à mesurer, un niveau, un maillet et une bâche sur laquelle placer les pièces seront nécessaires pour l'assemblage (non inclus).
- Enlevez le film protecteur supérieur des panneaux de toit avant l'assemblage; NE PAS retirer le film protecteur inférieur avant d'être prêt à insérer les panneaux de toit, afin d'identifier le côté supérieur.

### INSTRUCTION D'ANCRAGE:

- Un ancrage adéquat du cadre à la base et au mur est nécessaire pour la sécurité.
- Une structure non solidement ancrée a un risque de s'envoler lors de vents violents causant des dommages et des risques pour la sécurité.
- Le matériel et les outils requis pour l'ancrage varient en fonction de l'emplacement d'installation et ne sont pas fournis.
- Veuillez vérifier auprès de votre quincaillerie locale les ancrages appropriés à votre surface.

### SOIN ET MAINTENANCE:

- En cas de pièce défectueuse ou endommagée, ou pour toute autre question concernant le produit, veuillez contacter directement le fabricant.
- Veuillez avoir la liste des pièces et les numéros de pièces à portée de main lors de la commande ou de la demande de pièces de rechange.













### PANNEAUX DE TOIT:



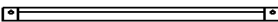
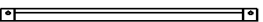
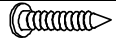
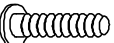
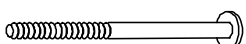
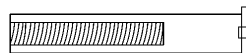
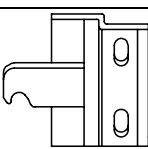
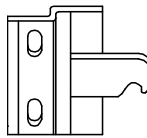





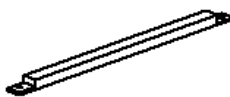

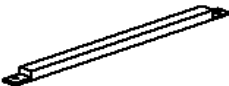
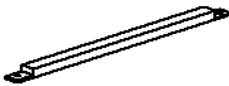
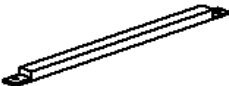

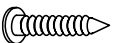
- Nettoyez doucement avec une solution savonneuse écologique et de l'eau à l'aide d'une éponge.
- N'utilisez pas de matériaux abrasifs, de brosses métalliques, de produits chimiques, de nettoyeurs puissants ou d'eau de javel.
- Rincer à l'aide d'un tuyau d'arrosage et sécher à l'air. S'il est retiré, assurez-vous qu'il est complètement sec avant le stockage.
- N'utilisez pas de nettoyeur haute pression.



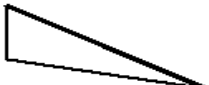

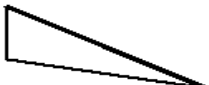
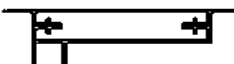
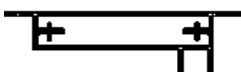
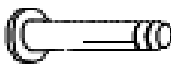

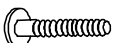
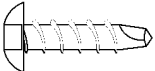



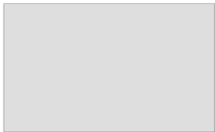
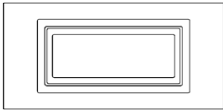

### STRUCTURE:

- Nettoyez doucement avec une solution savonneuse écologique et de l'eau à l'aide d'une éponge.
- N'utilisez pas de matériaux abrasifs, de brosses métalliques, de produits chimiques, de nettoyeurs puissants ou d'eau de javel.
- Rincer à l'aide d'un tuyau d'arrosage et sécher à l'air. N'utilisez pas de nettoyeur haute pression.
- S'il y a des imperfections voir le numéro de pièce de la peinture dans la liste des pièces pour obtenir une peinture de retouche correspondante.

DESCRIPTION	EMBALLE DANS LA BOITE	QTÉ	DESSIN	DESCRIPTION	EMBALLE DANS LA BOITE	QTÉ	DESSIN																																																																												
10-496-12 CADRE RÉGULIER A-3	2	2		10-497-12 CADRE ADJACENT À LA PORTE B-3	2	1																																																																													
	3	1			3	1		12-141-12 DEMI CADRE A-3 1/2	2	1		10-498-12 PORTE COULISSANTE C-3	2	1		3	1	3	1	10-499-12 CADRE POUR PORTE COULISSANTE D-3	2	1		11-544-12 PIÈCE DE CONNECTION E-3	4	12		3	1	4	2	11-545-12 RAIL DE PORTE SUPÉRIEUR F-3	4	2		11-546-12 RAIL DE PORTE INFÉRIEUR G-3	4	2		08-138-12 BUTOIR EN PLASTIQUE H-3	5	4		12-142-12 RÉCEPTEUR GAUCHE I-3	4	1		12-143-12 RÉCEPTEUR DROIT J-3	4	1		10-502-12 JOINT D'ANGLE K-3	4	2		12-155-12 POUTRE GAUCHE L-1	4	1		12-156-12 POUTRE DROITE L-2	4	1		10-503-12 RAIL AU MUR ML-3	4	1		10-504-12 RAIL AU MUR MR-3	4	1		10-505-12 JOINT POUR RAIL N-3	5	1		10-506-12 CROCHET POUR CHEVRON O-3	5	4		12-007-12 JOINT POUR PIGNON GAUCHE P-3	5	1	
12-141-12 DEMI CADRE A-3 1/2	2	1		10-498-12 PORTE COULISSANTE C-3	2	1																																																																													
	3	1			3	1		10-499-12 CADRE POUR PORTE COULISSANTE D-3	2	1		11-544-12 PIÈCE DE CONNECTION E-3	4	12		3	1	4	2	11-545-12 RAIL DE PORTE SUPÉRIEUR F-3	4	2		11-546-12 RAIL DE PORTE INFÉRIEUR G-3	4	2		08-138-12 BUTOIR EN PLASTIQUE H-3	5	4		12-142-12 RÉCEPTEUR GAUCHE I-3	4	1		12-143-12 RÉCEPTEUR DROIT J-3	4	1		10-502-12 JOINT D'ANGLE K-3	4	2		12-155-12 POUTRE GAUCHE L-1	4	1		12-156-12 POUTRE DROITE L-2	4	1		10-503-12 RAIL AU MUR ML-3	4	1		10-504-12 RAIL AU MUR MR-3	4	1		10-505-12 JOINT POUR RAIL N-3	5	1		10-506-12 CROCHET POUR CHEVRON O-3	5	4		12-007-12 JOINT POUR PIGNON GAUCHE P-3	5	1		12-008-12 JOINT POUR PIGNON DROIT Q-3	5	1									
10-499-12 CADRE POUR PORTE COULISSANTE D-3	2	1		11-544-12 PIÈCE DE CONNECTION E-3	4	12																																																																													
	3	1			4	2																																																																													
11-545-12 RAIL DE PORTE SUPÉRIEUR F-3	4	2		11-546-12 RAIL DE PORTE INFÉRIEUR G-3	4	2																																																																													
08-138-12 BUTOIR EN PLASTIQUE H-3	5	4		12-142-12 RÉCEPTEUR GAUCHE I-3	4	1																																																																													
12-143-12 RÉCEPTEUR DROIT J-3	4	1		10-502-12 JOINT D'ANGLE K-3	4	2																																																																													
12-155-12 POUTRE GAUCHE L-1	4	1		12-156-12 POUTRE DROITE L-2	4	1																																																																													
10-503-12 RAIL AU MUR ML-3	4	1		10-504-12 RAIL AU MUR MR-3	4	1																																																																													
10-505-12 JOINT POUR RAIL N-3	5	1		10-506-12 CROCHET POUR CHEVRON O-3	5	4																																																																													
12-007-12 JOINT POUR PIGNON GAUCHE P-3	5	1		12-008-12 JOINT POUR PIGNON DROIT Q-3	5	1																																																																													

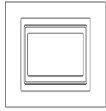
DESCRIPTION	EMBALLE DANS LA BOITE	QTÉ	DESSIN	DESCRIPTION	EMBALLE DANS LA BOITE	QTÉ	DESSIN
10-509-12 EMBOUT POUR CHEVRON DE TOIT R-3	5	7		12-146-12 CHEVRON GAUCHE S-3	4	1	
12-147-12 CHEVRON DROIT T-3	4	1		12-148-12 CHEVRON RÉGULIER U-3	4	5	
10-513-12 JOINT CENTRAL POUR TOIT V-3	5	2		10-514-12 JOINT CENTRAL POUR TOIT W-3	5	4	
10-515-12 BORDURE DE FINITION X-3	5	2		10-516-12 BORDURE DE FINITION Y-3	5	4	
08-156-12 VIS Z-3	5	10	 (M4*16mm)	08-158-12 BOULON Bb-3	5	28	 (M6*16mm)
08-161-12 BOULON Cc-3	5	23	 (M6*73mm)	12-037-12 VIS FEMELLE Cc-3-2	5	12	 M6*60mm
08-169-12 LOQUET POUR PORTE GAUCHE Dd-L-3	5	2		08-165-12 LOQUET POUR PORTE DROIT Dd-R-3	5	2	
08-167-12 VIS Ee-3	5	10	 M6x63.5mm	08-168-12 BOULON Ff-3	5	16	 (M6*12mm)
08-187-12 RONDELLE Gg-3	5	23		12-161-12 ÉCROU Hh-3-2	5	4	
08-193-12 BOUCHON DE PLASTIQUE Ii-3	5	10		10-517-12 BARRE TRANSVERSALE EXTRÉMITÉS Jj-3	5	2	

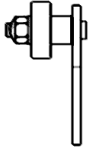
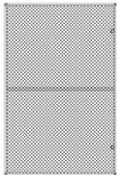
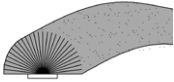
DESCRIPTION	EMBALLÉ DANS LA BOITE	QTÉ	DESSIN	DESCRIPTION	EMBALLÉ DANS LA BOITE	QTÉ	DESSIN
10-518-12 BARRE TRANSVERSALE RÉGULIÈRE Kk-3	5	4		10-519-12 RENFORT POUR TOIT LI-3	5	2	
10-520-12 RENFORT POUR TOIT Mm-3	5	4		08-134-12 EMBOU DU RAIL DE PORTE SUPÉRIEUR Nn	5	4	
08-135-12 VIS Oo-3	5	8	 (M4*12mm)	12-149 (63 ¼ x 24 ½") PANN. DE TOIT GAUCHE+DROIT Pp-3	1	4	
12-150 (63 ¼ x 23") PANN. DE TOIT RÉGULIER Qq-3	1	8		12-151 PANN. PIGNON ARRIÈRE GAUCHE Rr-3	1	1	
12-152 PANN. PIGNON AVANT GAUCHE Ss-3	1	1		12-153 PANN. PIGNON ARRIÈRE DROIT Tt-3	1	1	
12-154 PANN. PIGNON AVANT DROIT Uu-3	1	1		10-527-12 GUIDE MURAL GAUCHE Vv-3	4	1	
10-528-12 GUIDE MURAL DROIT Ww-3	4	1		10-529-12 VIS POUR ATTACHER AU MUR Xx-3	5	18	
10-530-12 REBOUCHEUR RÉGULIER Yy-3	5	4		10-531-L-12 REBOUCHEUR POUR EXTRÉMITÉ Zz-3-L	5	1	
12-047-12 BOULON Ww	5	12	 M5*15	13-045-12 VIS AUTO- TARAUDEUSE PQ-3	5	4	
10-531-R-12 REBOUCHEUR POUR EXTRÉMITÉ Zz-3-R	5	1		23-007-12 BOUCHON EN PLASTIQUE Kk	5	4	

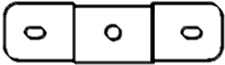
PIÈCES DE RECHANGE DISPONIBLES			
DESCRIPTION	DESSIN	DESCRIPTION	DESSIN
10-435-12 FENÊTRE PVC (en cadre)		85-014 REPLACEMENT DE MOUSTIQUAIRE (pas de cadre)	
12-176-12 FENÊTRE PVC POUR MOITIÉ CADRE A-31/2		85-417-S SPLINE RONDE POUR LE MOUSTIQUAIRE	
10-493 FENÊTRE PVC (matériel de remplacement uniquement)		11-824-12 PANNEAU PLASTIQUE INFÉRIEUR (pour panneaux muraux)	
85-417-P SPLINE RONDE POUR LA FENÊTRE PVC		11-825-12 PANNEAU PLASTIQUE INFÉRIEUR (pour portes)	
15-123-12 GOUPILLE DE FENETRE		12-173-12 PANNEAU PLASTIQUE INFÉRIEUR POUR MOITIÉ CADRE A-3 1/2	
13-055 FENÊTRE PC (pour porte coulissante)		15-097-12 MONTAGE DE ROUE DE PORTE	
12-174-12 MOUSTIQUAIRE (en cadre)		10-458 COUPE-FROID DE REPLACEMENT 124"	
12-175-12 MOUSTIQUAIRE POUR MOITIÉ CADRE A-3 1/2		15-125-12 SUPPORT DE MONTAGE POUR CHEVRON (U-3)	
<b>*PAS INCLUS DANS LA BOITE</b>			
<b>DESCRIPTION</b>	<b>COULEUR</b>	<b># DE PIÈCE</b>	
PEINTURE À SPRAY	SABLE	11-699	
STYLO À PEINTURE		18-245	

ENLEVEZ L'AUTOCOLLANT AVANT L'ASSEMBLAGE

↑ THIS SIDE UP CE CÔTÉ VERS LE HAUT ↑

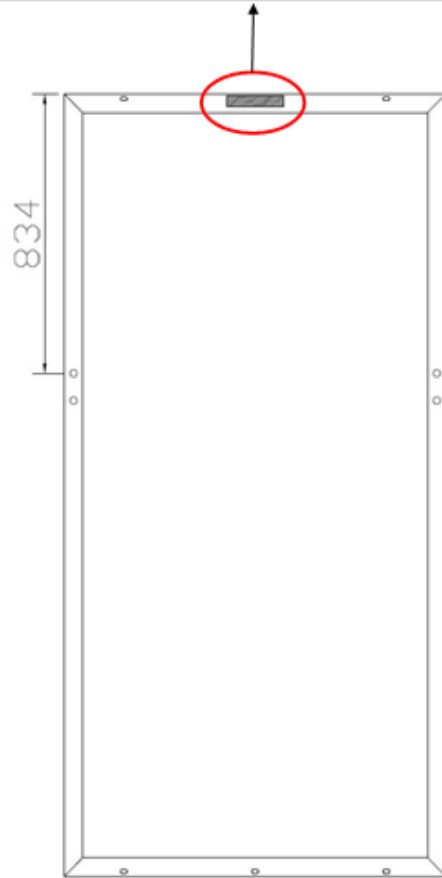

D-3 FRAME

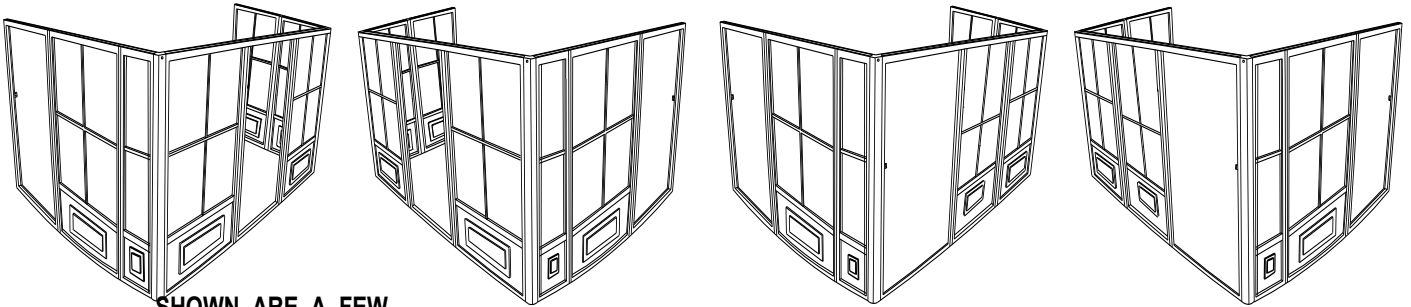

**SHOWN ARE A FEW  
POSSIBILITIES**

THE SLIDING DOOR CAN BE PLACED IN ANY LOCATION  
AS LONG AS THE FRAME NEXT TO DOOR IS BESIDE IT.

LA PORTE COULISSANTE PEUT ETRE PLACÉE N'IMPORTE OÙ  
TANT QUE CADRE ADJACENT À LA PORTE EXT À CÔTÉ DE LA  
PORTE.

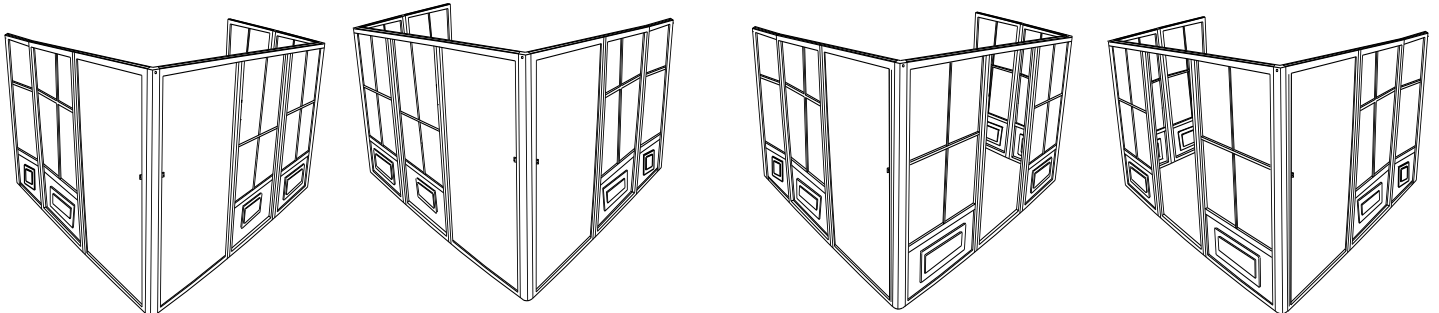

**OUTILS REQUIS:** Tournevis, Couteau, Lime (douce), Pincettes à bec effilé, Maillet en caoutchouc, Échelle (Minimum de 6 pi de hauteur), Spatule, Perceuse électrique, Tube de silicone, Foret de 5/16 pour ciment (selon la surface)

**AVANT DE COMMENCER:**

Assurez-vous d'avoir une base solide comme du ciment ou un patio en bois, qui n'ait pas plus d'inclinaison que 1 po par 8 pi. Ne placez pas le solarium en dessous d'un arbre ou la pente d'un toit, la neige ou la glace pouvant glisser et causer l'effondrement du solarium. Ne détruisez pas les boîtes avant que l'abri soit complètement assemblé. Veuillez vérifier le contenu de chaque boîte à l'aide de la liste des pièces.

**ÉTAPE #1**

Avant d'assembler les cadres des portes, décidez vers quelle direction elles s'ouvriront. À l'entrée du solarium, utilisez le cadre D-3 pour l'ouverture de la porte et B-3 pour la direction vers laquelle elle s'ouvrira. Assurez que les cadres A-3 1/2 sont à l'avant des côtés. Utilisez le joint E-3 entre les extrémités du cadre et utilisez deux (2) joints K-3 pour les coins. **Voir Pg 4.**

**REMARQUE:**

Lorsque vous placez le cadre d'ouverture de porte, assurez-vous que les insertions du cadre soient à l'intérieur et sur la moitié supérieure du cadre du solarium puisque la porte sera fixée à l'intérieur en raison de l'espace libre.

**REMARQUE:**

Lorsque vous glissez les connecteurs, secouez le cadre pour qu'ils glissent plus facilement. N'utilisez pas d'outils pour les orcer. S'il le faut, nettoyez la peinture avec la lime et assurez-vous que les extrémités du cadre et les joints ne sont pas pliés ou distordus. Utilisez des pincettes à bec effilé pour les redresser au besoin.

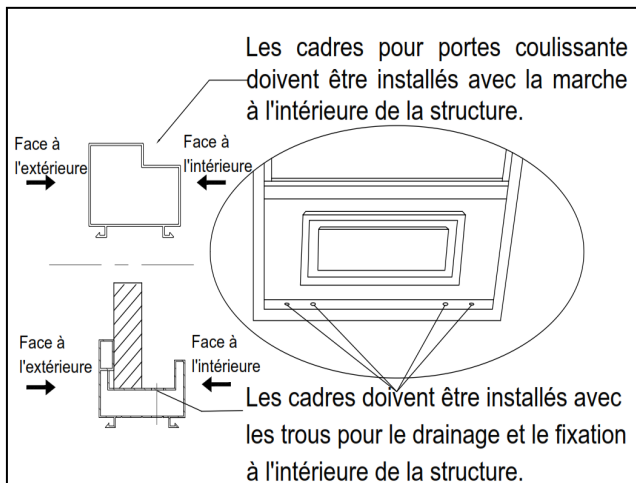
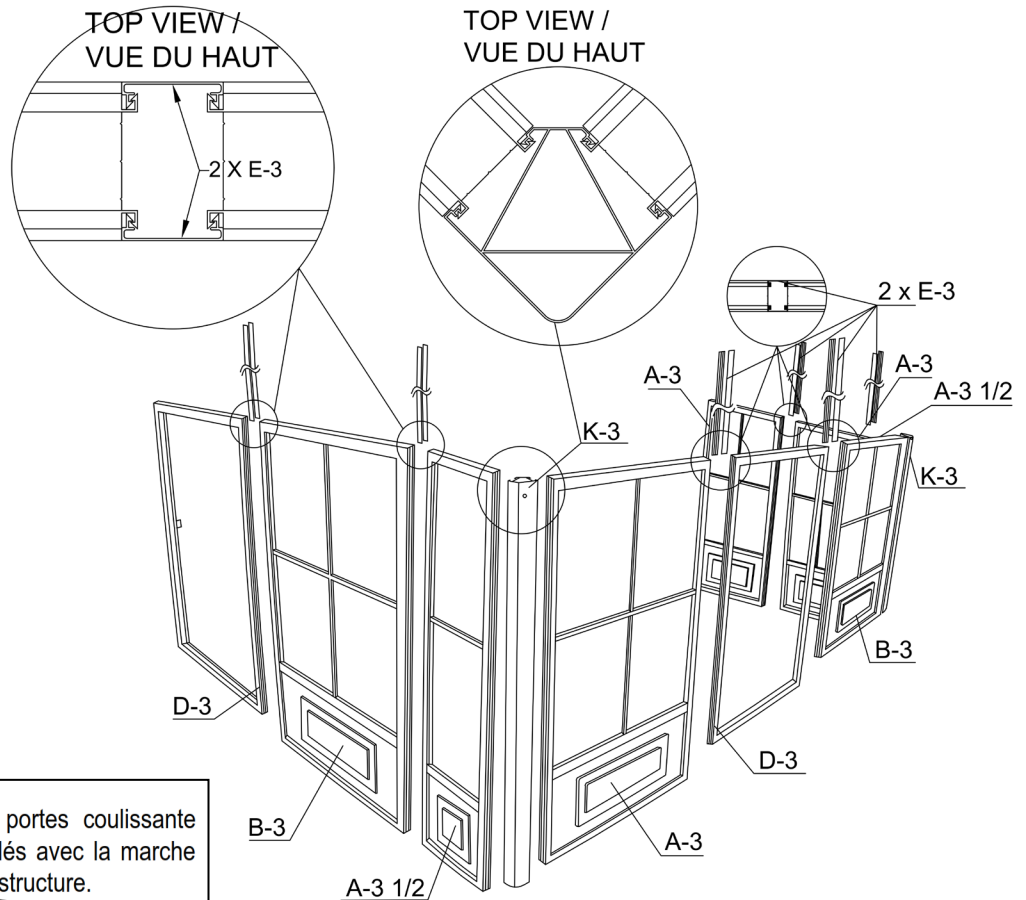



## ÉTAPE #2

Glissez les guides verticaux Vv-3 à gauche et Ww-3 à droite sur les 2 extrémités des cadres, le long des rainures, et secouez pour faciliter le positionnement. Glissez ensuite deux (2) Yy-3 et un (1) Zz-3 de gauche à droite sur la partie supérieure du cadre. Le sillon sur la pièce devrait être vers l'intérieur de la structure. Répétez à partir du côté droit avec deux (2) Yy-3 et un (1) Zz-3, tout en les espaçant également.

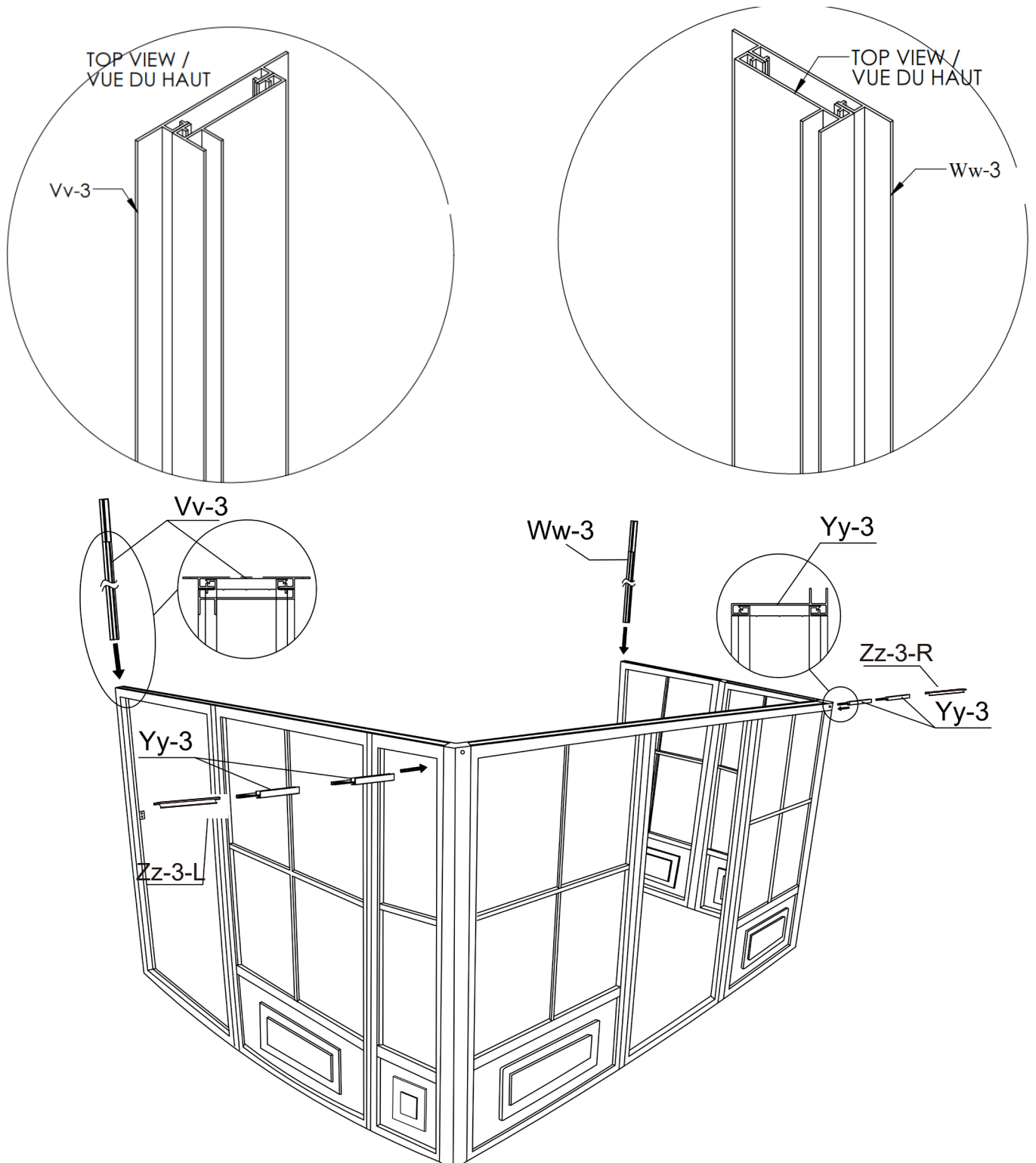

**ASSEMBLEZ LES PIÈCES AVANT DE LES FIXER AU MUR.**

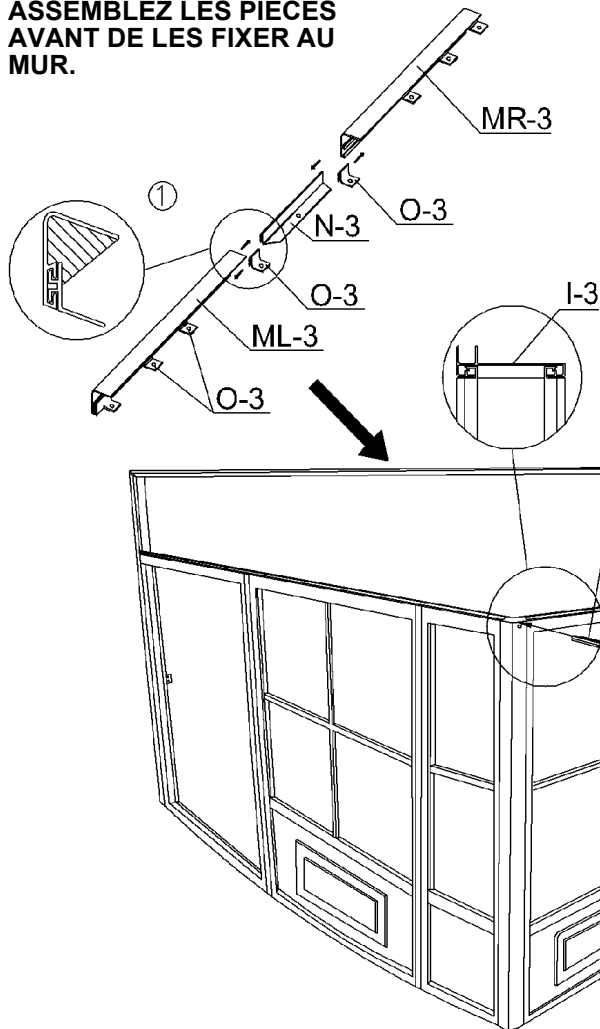

**ÉTAPE #3**

Glissez les Crochet pour chevron O-3 dans ML-3 et MR-3 et placez-les de manière égale. Joignez ML-3 et MR-3 avec N-3. Une fois assemblé, levez la barre murale au-dessus des guides verticaux Vv-3 et Ww-3 (approximativement 96" du sol).

Fixez la barre murale (ML-3, MR-3) et les guides verticaux (Vv-3 and Ww-3) au mur en perçant à travers l'aluminium, à des intervalles de 16" et en utilisant les vis Xx-3 ou des vis approprié pour le mur d'installation. Insérez les 2 guides horizontaux I3 & J3 sur la partie supérieure du cadre. Assurez-vous que les 2 cadres sont au même niveau. S'ils ne le sont pas, utilisez des cales pour y arriver. N'utilisez pas des outils pour les forcer.

**REMARQUE:**

Une fois la barre murale installée, appliquez du silicone au long de celle-ci et sur le joint des deux barres. **Le silicone n'est pas inclus.**

**ÉTAPE #4**

Tournez le côté du polycarbonate exposé vers l'extérieur sur le guide horizontal gauche I-3, utilisez un (1) panneau Rr-3, un (1) joint P-3 et un (1) panneau Ss-3. Faites de même sur le côté droit avec un (1) panneau Tt-3, un (1) joint Q-3 et un (1) panneau Uu-3 par dessus le panneau horizontal J-3. Attachez P-3 et Q-3 à I-3 et J-3 respectivement avec des vis auto-taraudeuses (PQ-3).

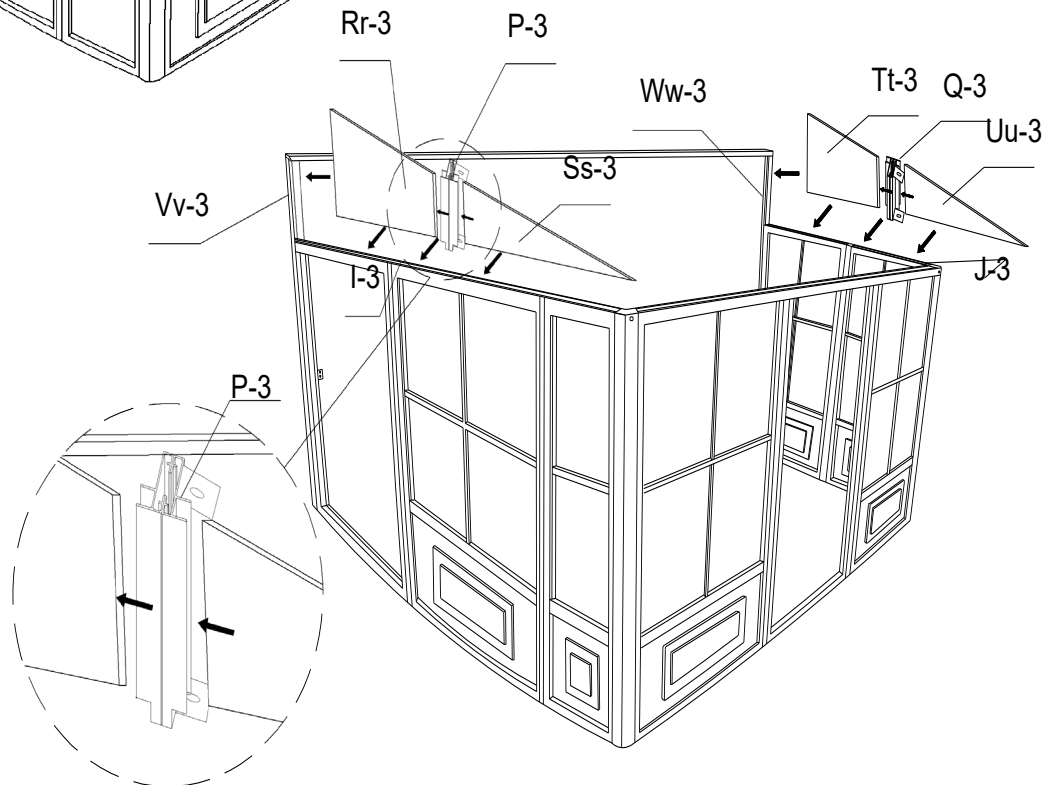

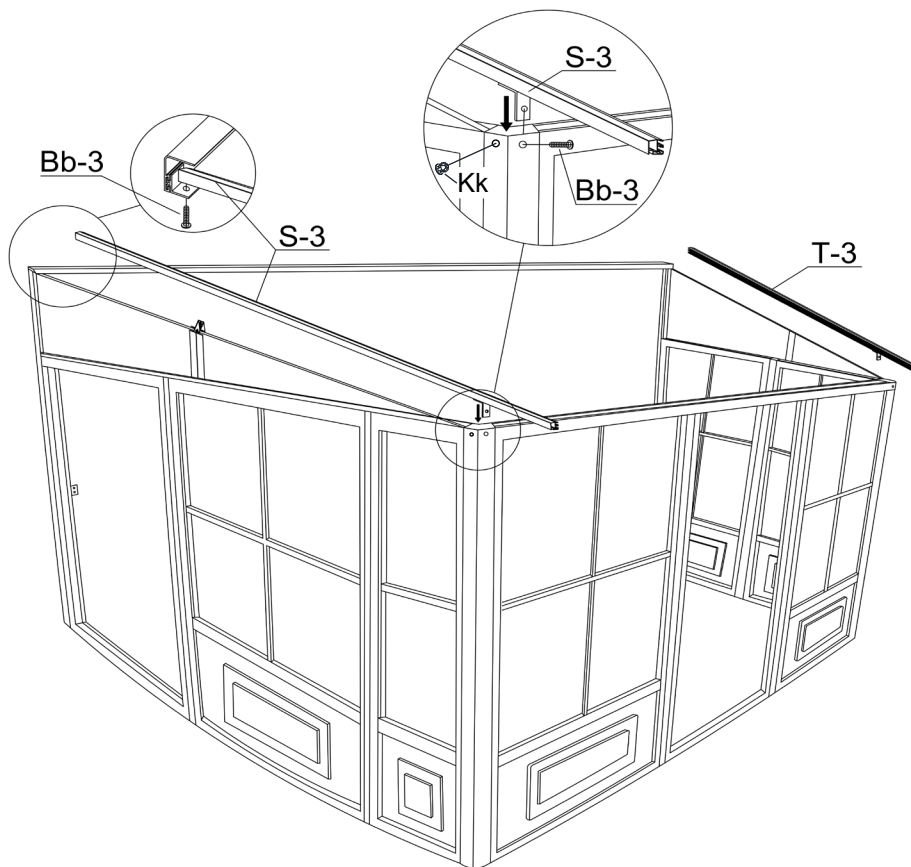

## ÉTAPE #5

Placez le chevron à droit T-3 sur le dernier crochet et fixez-le avec une vis Bb-3. Continuez à visser jusqu'au joint K-3 grâce à la vis Bb-3. Attachez au crochet de Q-3 avec vis auto-taraudeuse (PQ-3). Répétez la même procédure à gauche avec le chevron S-3.

## ÉTAPE #6

### **LES PORTES DOIVENT ÊTRE ASSEMBLÉES À L'INTÉRIEUR DU SOLARIUM.**

Glissez le rail supérieur pour porte F-3 sur les roues de la porte coulissante C-3. Glissez le rail inférieur pour porte G-3 et assurez-vous que les insertions sont proches pour les fixer au cadre. Utilisez un boulon Bb-3 pour fixer le H-3 sur la partie supérieure de chaque extrémité de la barre pour porte F-3. Utilisez les vis Oo-3 pour fixer la barre supérieure pour porte et le couvercle Nn-3 sur chaque extrémité de la barre.

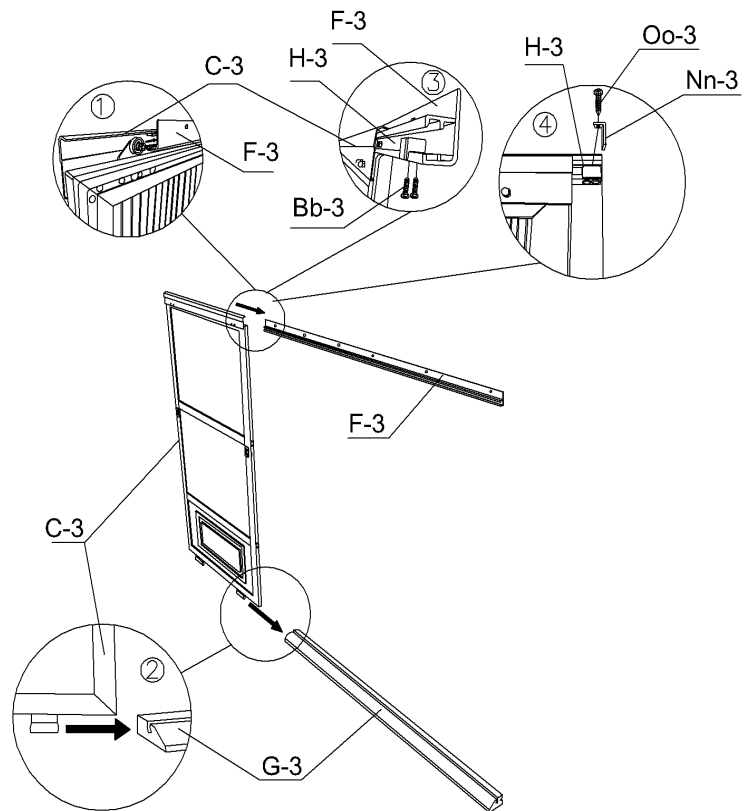

## ÉTAPE #7

Soulevez la porte et le rail à l'intérieur du solarium et positionnez-les sur l'ouverture de la porte en les vissant sur la partie supérieure. Utilisez des boulons (Ww) et des rondelles (Gg-3) à l'intérieur en premier, ensuite des vis femelles (Cc-3-2) à l'extérieur pour l'assemblage de la partie supérieure. Consultez le diagramme ci-dessous. Attachez le rail inférieur avec des boulons (Cc-3) et rondelles (Gg-3). Placez le loquet de la porte sur le côté requis et pour la verrouiller, ajustez-la au besoin.

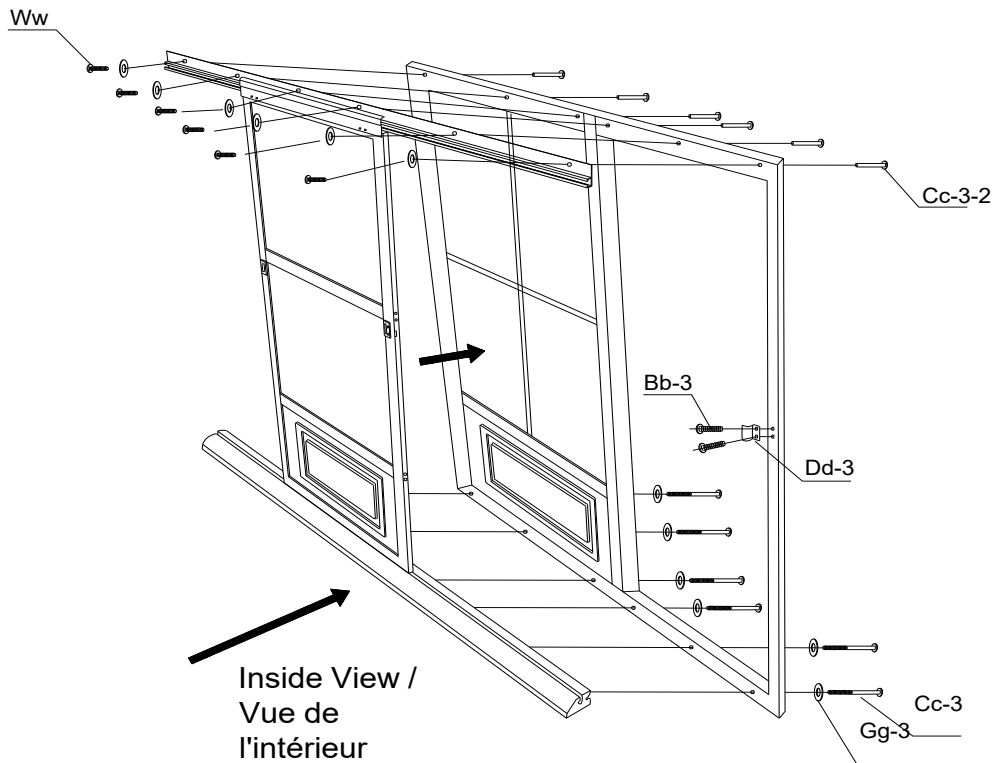
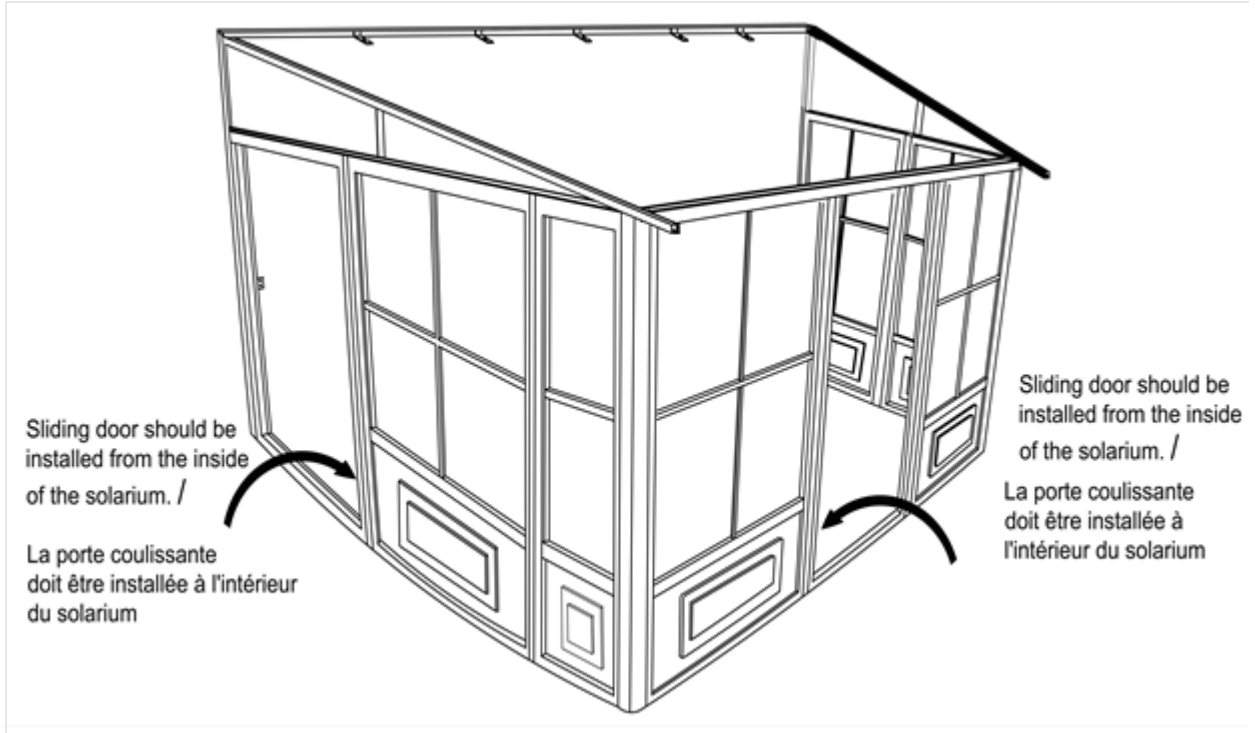

## ÉTAPE #8

Placez les chevrons U-3 sur le top du milieu de chaque panneau avec des vis Bb-3 et vissez manuellement deux (2) vis Z-3 sur le cadre. Fixer U-3 sur chaque joint et utiliser les vis Z-3 manuellement. N'utilisez pas la perceuse électrique.

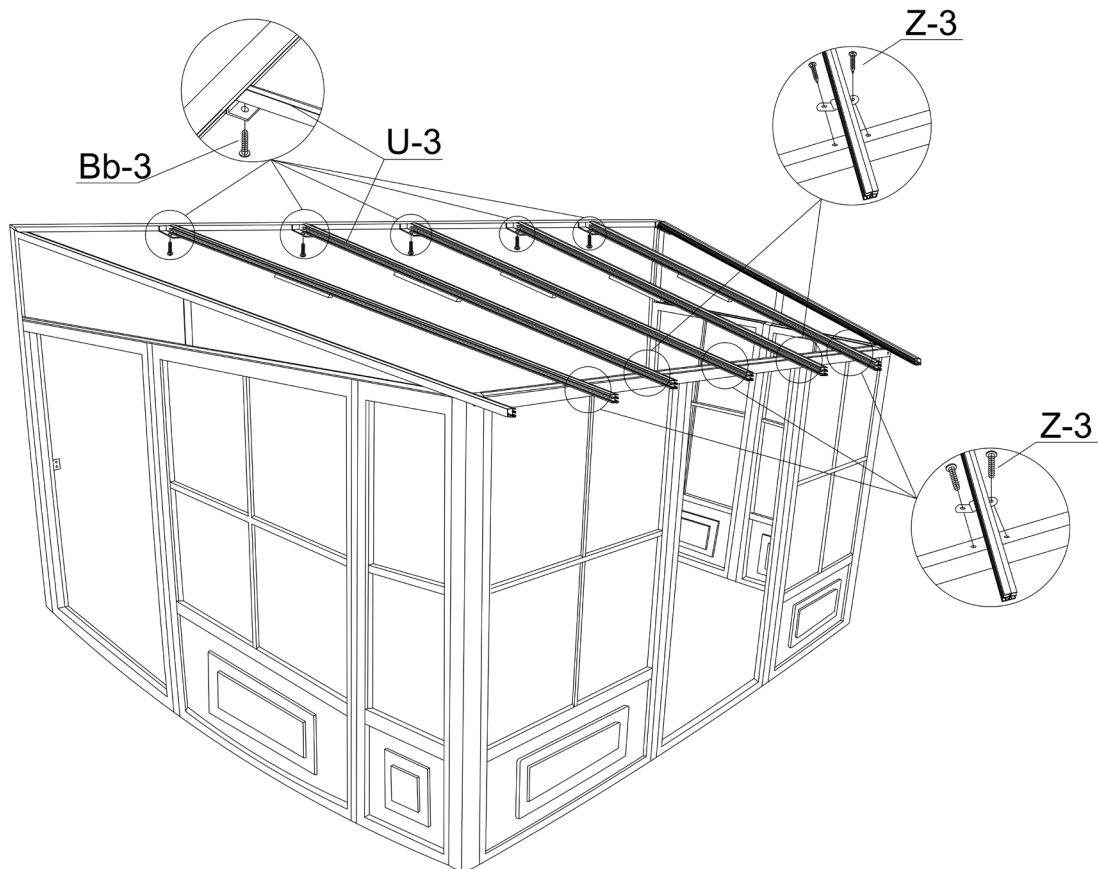

## ÉTAPE #9

Enlever la couche protectrice des deux (2) côtés de chaque panneau et assurez-vous que le côté supérieur ait face à la lumière. Insérez et glissez les sur la rainure supérieure des chevrons jusqu'au fond. Le Pp-3 doit aller en premier et en dernier tandis que les panneaux Qq-3 doivent être entre les deux.

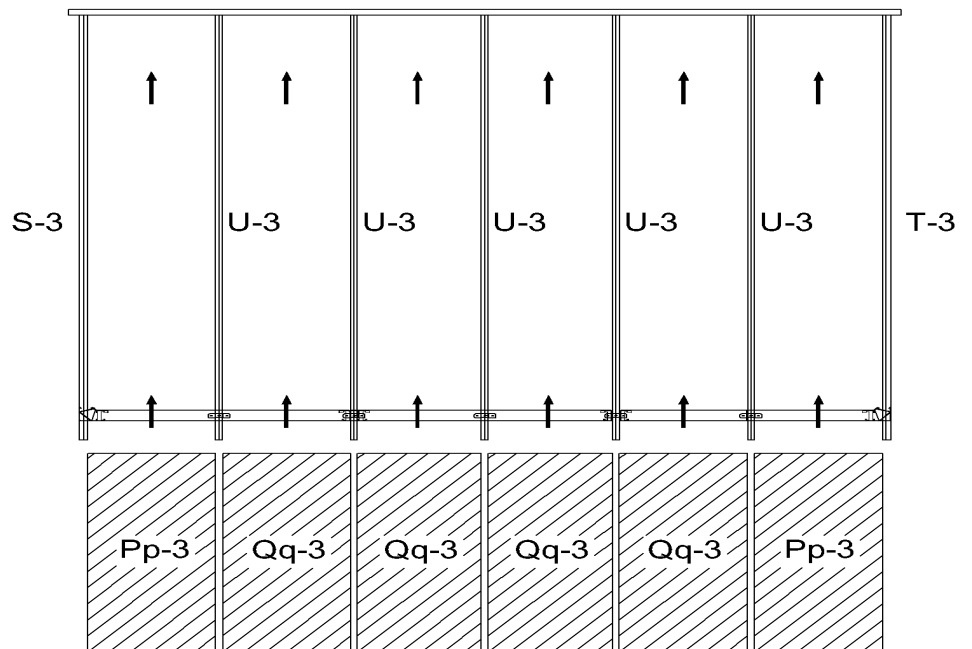

## ÉTAPE #10

Insérez le joint central du toit en aluminium entre les chevrons et assurez-vous que les trous sont sur la partie inférieure. Glissez-le sur les chevrons supérieurs et inférieurs jusqu'aux panneaux. Assurez-vous que ces derniers se trouvent à l'intérieur du chevron du joint central du toit en aluminium. Insérez un V-3 sur une des extrémités, ensuite toutes les W-3 et les V-3 restants à la fin. Cognez légèrement avec le maillet en caoutchouc si nécessaire.

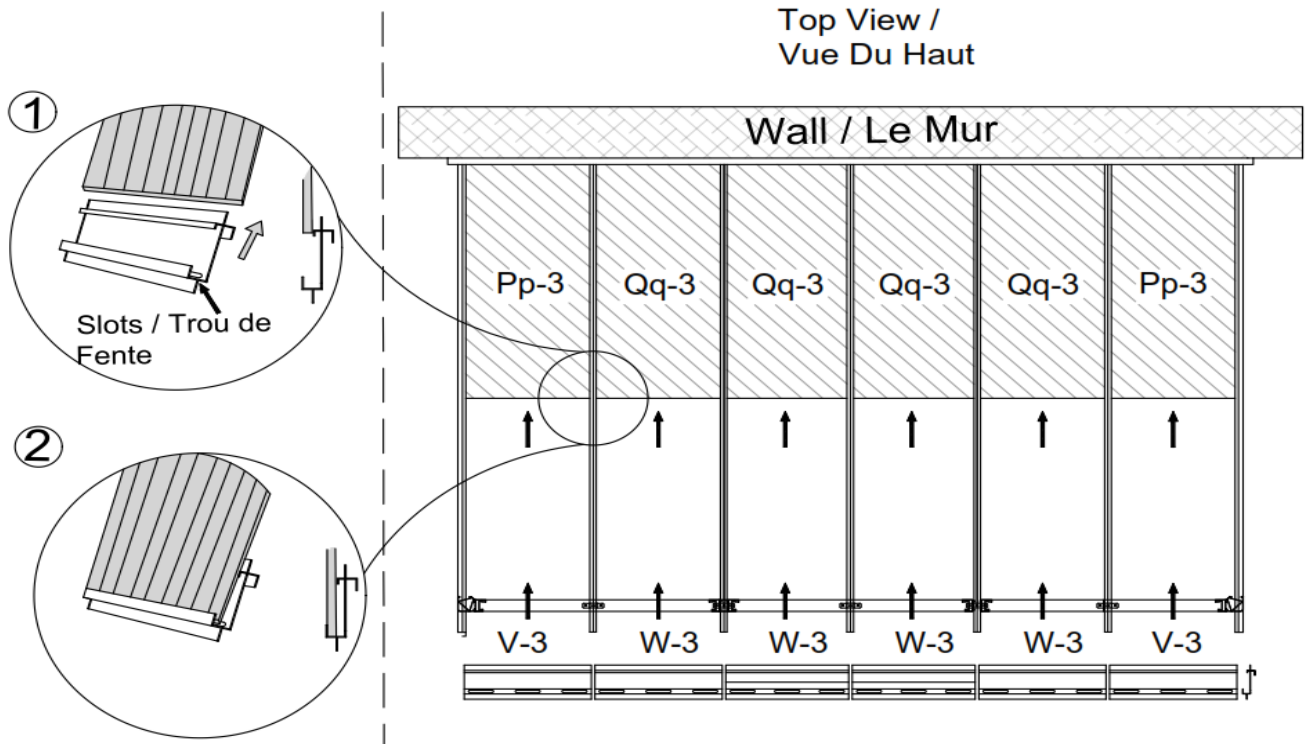

## ÉTAPE #11

Insérez la deuxième rangée de panneaux sur la rainure inférieure du chevron. Glissez les panneaux jusqu'à ce qu'ils rejoignent les pièces en aluminium entre les panneaux et cognez légèrement pour les déplacer sur la rainure en aluminium. Utilisez une spatule pour le faire au besoin. Insérez deux (2) Pp-3 sur l'autre extrémité et ensuite les panneaux Qq-3.

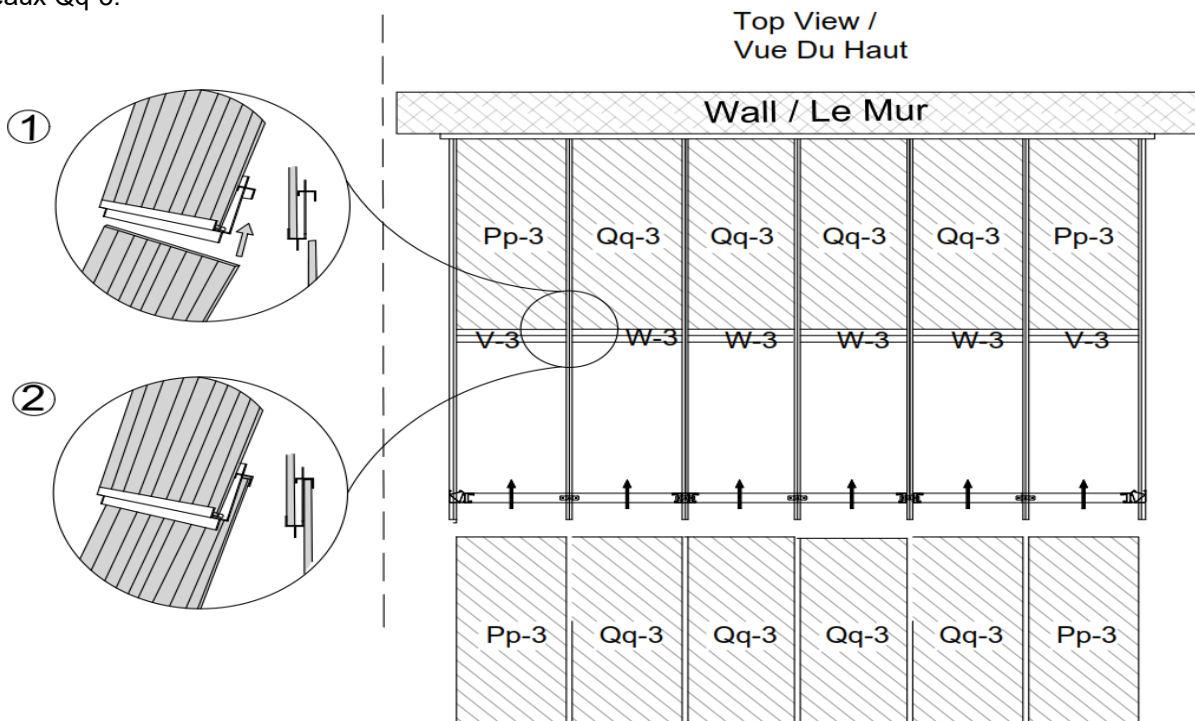

## ÉTAPE #12

À l'autre extrémité, ajoutez les bordures X-3, un (1) crochet R-3 et vissez une vis Bb-3 manuellement, n'utilisez pas un foret électrique. Ajoutez une bordure Y-3 et répétez jusqu'à ce que vous ayez atteint l'autre extrémité. Ajoutez ensuite la bordure X-3.

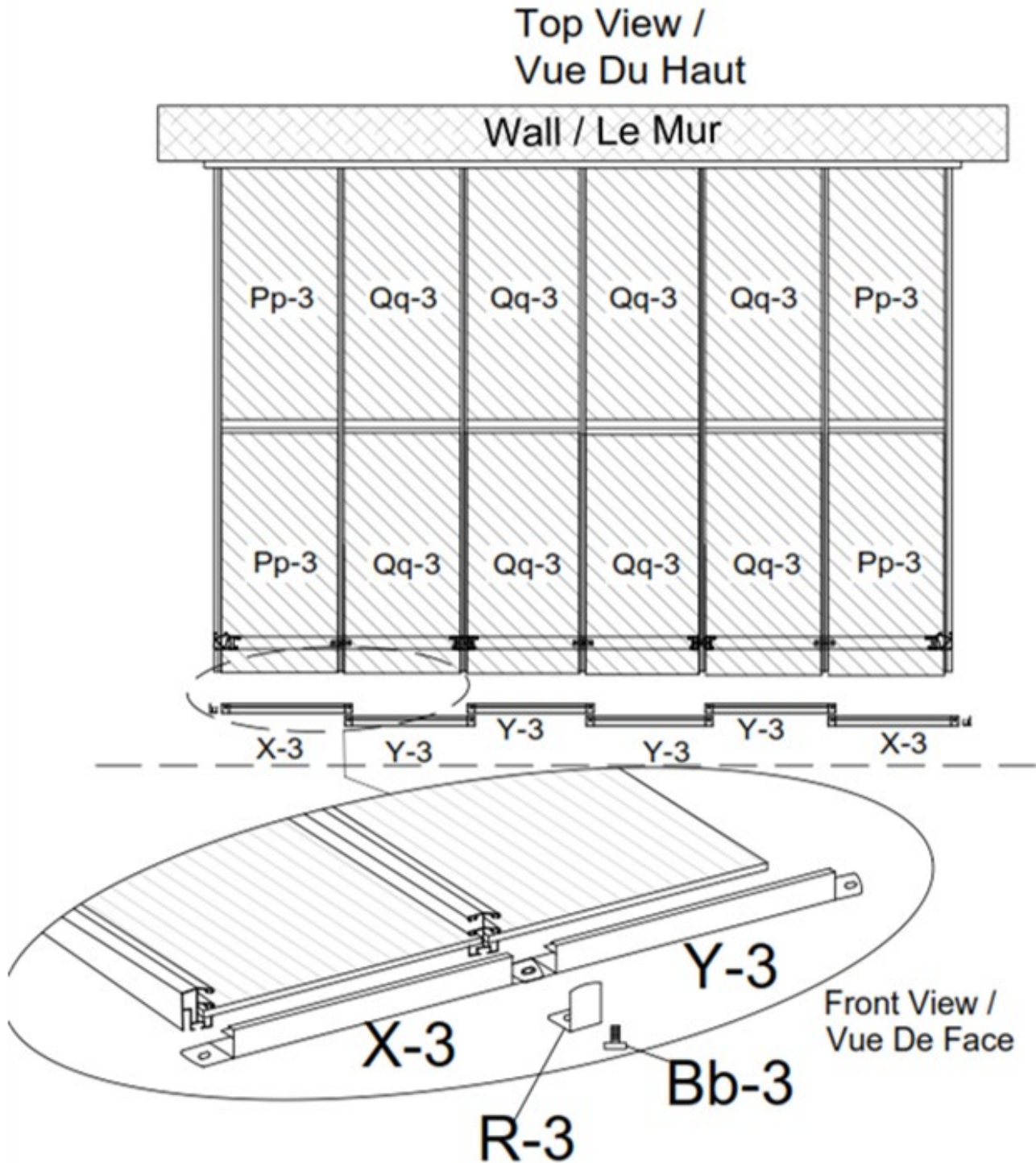

## ÉTAPE #13

À l'intérieur du solarium, il y a deux rangées d'insertions filetées sous chaque chevron. Commencez la rangée supérieure avec un Jj-3 aux extrémités et Kk-3 entre les panneaux, vissez avec les vis Ff-3. Utilisez des vis Ff-3 pour la rangée inférieure, Ll-3 aux extrémités et Mm-3 entre les panneaux. Assemblez la poutre L-1 et L-2, puis attachez aux chevrons avec les boulons Cc-3. Assurez-vous de les visser manuellement et fermement.

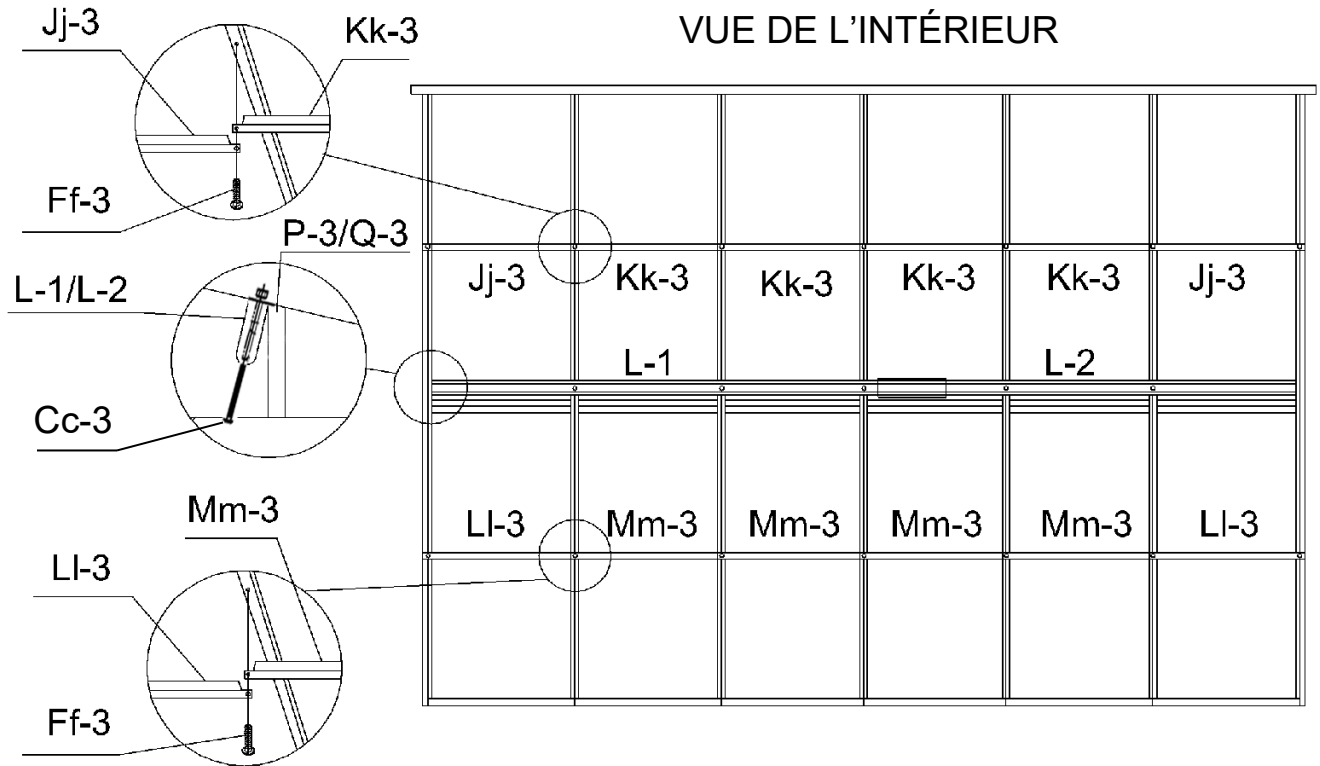

## ÉTAPE #14

Fixez le solarium au sol ou plancher en utilisant les vis et les écrans protecteurs fournis. Consultez le diagramme ci-dessous.

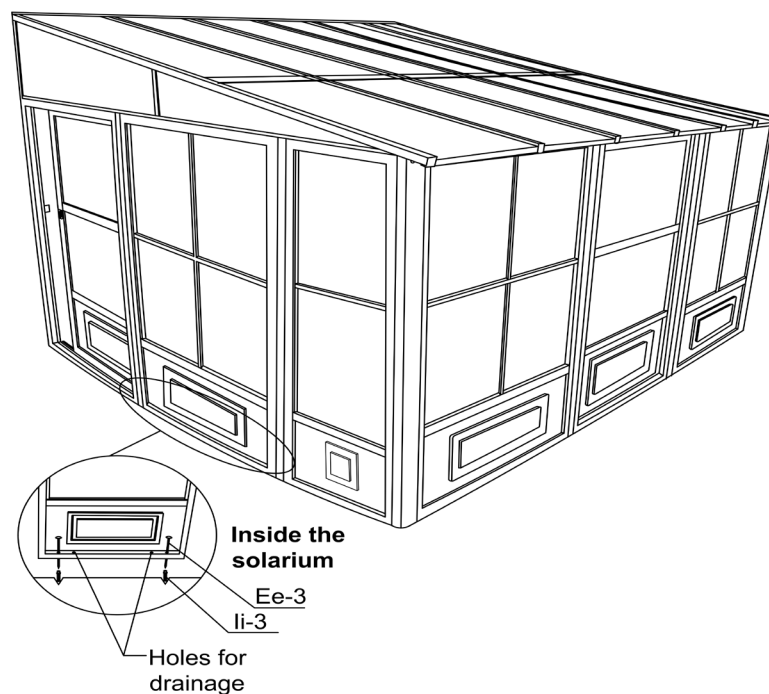



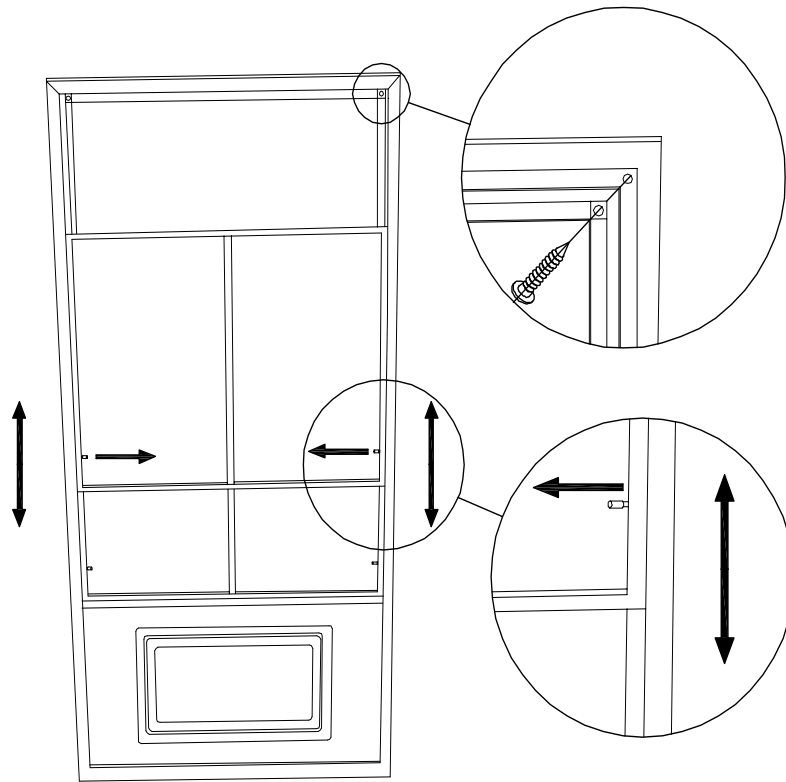

## **NOTES SPÉCIALES**

Pour retirer un écran, enlevez deux (2) vis de la partie supérieure du cadre et tirez vers les côtés vers les extrémités des poignées pour l'enlever. Pour retirer les panneaux contre le vent, poussez ou déplacez-les de côté et assurez-vous que la goupille n'est pas verrouillée. Retirez les panneaux doucement car ils sont faciles à enlever.

### **REMARQUE:**

Ce solarium n'est pas imperméable à l'eau. Pour la meilleure protection contre la pluie, fermez les fenêtres de chaque panneau avec la fenêtre extérieur au milieu, et celle d'intérieur en haut.

### **DIRECTIVES DE NETTOYAGE:**

Utilisez seulement de l'eau savonneuse tiède et non des produits de nettoyage puissants ou d'abrasifs. Assurez-vous de retirer l'accumulation de neige et/ou la glace.

### **AVERTISSEMENT:**

- 1) N'utilisez pas le BBQ ou tout autre produit inflammable à l'intérieur du solarium.
- 2) **Enlevez la neige du toit.**

## **\*Suggestions**

Les éléments mentionnés ci-dessous ne sont que des suggestions afin de permettre le drainage, elles varieront en fonction de votre revêtement de sol - matériel, platitude et pente.

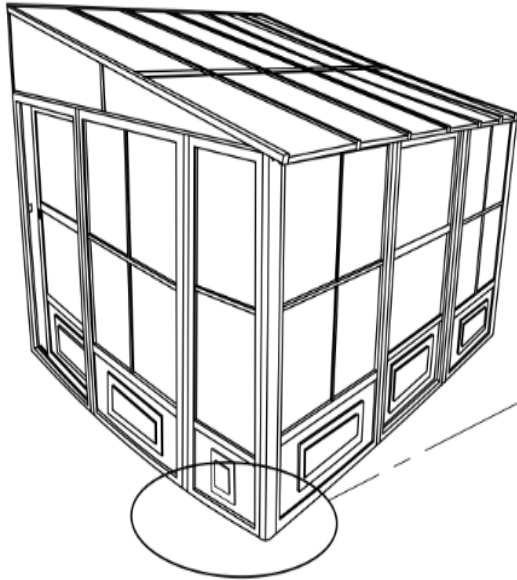

Apply silicone to prevent water from seeping from under the frame /

Appliquez du silicone pour empêcher l'eau de s'infiltrer sous le cadre

**INSIDE VIEW /  
VUE DE  
L'INTÉRIEUR**

**For Concrete Flooring**  
Seal the provided drain holes on the inside layer

**Pour Sol en Béton**  
Fermer les trous de drainage fournis sur la couche intérieure

**For Concrete Flooring**  
**Pour Sol en Béton**

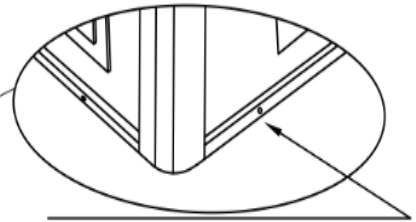

On the outside face, it is suggested to drill holes at the bottom end of the panels to permit drainage when installing on concrete floor /

Sur la face extérieure, il est suggéré de percer des trous à l'extrémité inférieure des panneaux pour permettre le drainage.

**INSIDE VIEW /  
VUE DE  
L'INTÉRIEUR**

**For Wooden Deck**  
Drill through the wooden deck where drain holes are located to permit drainage

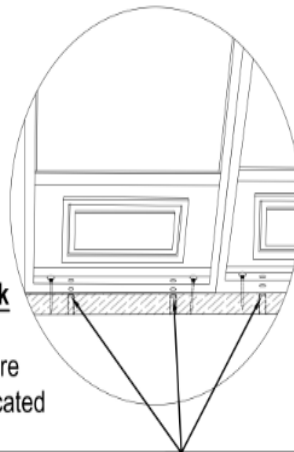

**Pour Deck en Bois**  
Forez les ponts où se trouvent les trous de drainage pour permettre de l'eau passer à travers.

NOTE: LES DIMENSIONS SONT APPROXIMATIVES.

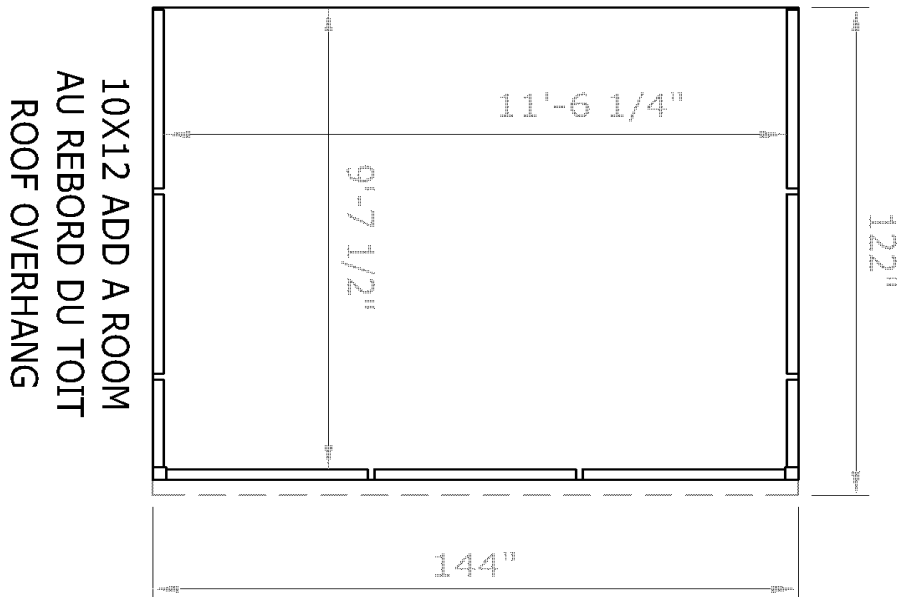
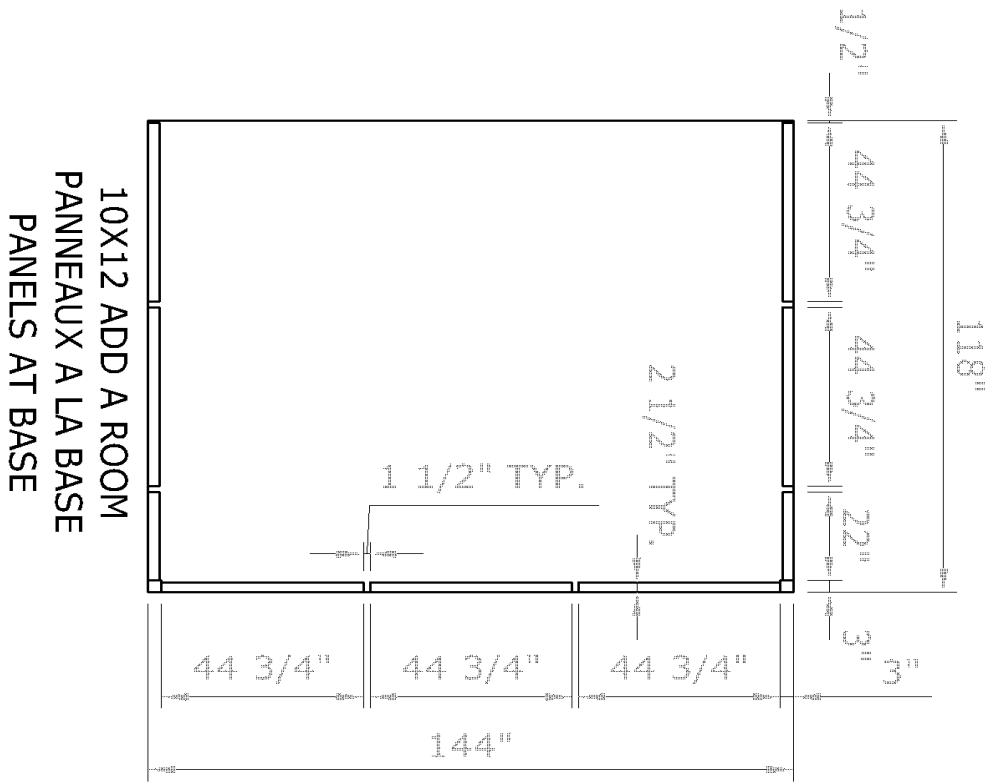

# GARANTIE

---

Inspectez soigneusement le contenu de l'emballage afin de vérifier si certaines composantes sont manquantes ou endommagées. Advenant que certaines pièces soient manquantes ou endommagées, **ne retournez pas le produit à l'endroit où vous l'avez acheté**; contactez plutôt le département d'expérience client de Gazebo Penguin

Montréal : (514) 276-5643

Ailleurs au Canada et États-Unis : 1-800-737-7174

info@gazebopenguin.com

Ce produit a été conçu et fabriqué afin de répondre aux normes les plus exigeantes en matière de qualité et de durabilité. Sous réserve des sections « conditions d'application de la garantie » et des « limitations à la garantie » ci-dessous, il est garanti contre les défauts matériels ou de fabrication:

- 1 AN SUR LES FENÊTRES
- 2 ANS SUR LA TOILE
- 5 ANS SUR LA STRUCTURE

Advenant que le produit soit endommagé ou que la période de garantie soit expirée, veuillez contacter le département d'expérience client de Gazebo Penguin afin d'obtenir une liste complète des pièces de remplacement et des prix.

## LIMITATIONS ET EXCLUSIONS À LA GARANTIE

1. Ce produit n'est pas garanti contre les dommages causés par le vent, la chute d'objets, le feu, les animaux, la végétation, le vandalisme et les conditions climatiques extrêmes
2. Les effondrements d'abris causés par une accumulation de neige, de glace et de vents
3. Le toit doit être maintenu libre en tout temps d'accumulation de neige et de glace.
4. Tous les dommages pouvant être causés par des accumulations de neige et de glace ne sont pas couverts par la garantie. La neige et la glace doivent être enlevées du toit, de la droite vers la gauche, par sections de cinq pieds (5) à la fois.
5. L'enlèvement de la neige et de la glace du produit fait par l'intérieur peut endommager ledit produit et de plus causer possiblement des blessures graves à la (aux) personnes(s) impliquée(s) à l'enlèvement question.
6. Il est fortement recommandé que le produit ne soit pas placé de manière adjacente à un immeuble ou des arbres, car la neige ou la glace peut glisser sur le toit. Advenant que le produit soit placé de manière adjacente à un immeuble ou un arbre, des précautions supplémentaires doivent être prises afin de s'assurer qu'il n'y a aucune accumulation de neige ou de glace pouvant causer un poids excessif au produit.
7. Le produit ne sera garanti que s'il est installé conformément aux instructions écrites de Gazebo Penguin incluses avec le produit.
8. Le produit n'est pas garanti s'il a été ancré incorrectement. En particulier, les câbles guides doivent être installés tel qu'illustré. Les ancrages ne sont pas inclus pour ces câbles guides et ils dépendent du sol sur lequel l'abri est installé.
9. Advenant que le sol ne soit pas gelé lors de l'installation du produit, en plus des crochets de plancher et clous, des poids (non inclus) d'au moins 300 livres pour chaque zone de 11' x 16' doivent être installés.
10. L'infiltration d'eau par les coutures n'est pas considérée comme un défaut manufacturier.
11. Ce produit n'est pas garanti contre la condensation, laquelle peut se produire si le produit n'est pas installé sur de l'asphalte et que le sol n'est pas complètement gelé à l'installation.
12. Le toit doit être gardé à l'intérieur si la température extérieure chute sous +45°F/+7°C et ce, jusqu'à ce qu'il soit placé sur le châssis. Sinon, les fenêtres peuvent briser et de tels bris ne seront pas couverts par la garantie.
13. Le matériel de couverture de cette unité a été traité pour résister aux dommages causés par les rayons ultraviolets du soleil. Cependant, il est obligatoire que ce produit soit démonté et entreposé pendant les mois d'été dans le but de prolonger la durée de ce produit.
14. La toile doit être propre et sèche avant le remisage. Nous recommandons fortement que le carton d'emballage original dans lequel le produit a été livré soit conservé pour l'entreposage hors-saison.
15. La décoloration et l'usure normale de la toile. La couleur du matériel peut naturellement changer avec le temps.

## AVERTISSEMENT

Les portes de l'unité doivent être gardées fermées en tout temps, sauf si un moteur est en opération, puisqu'il existe alors un danger d'asphyxie.

---

**DO NOT DESTROY THE BOXES UNTIL COMPLETELY ASSEMBLED  
FOR FUTURE REFERENCE,  
TAKE PICTURES OF ALL SIX SIDES OF EACH OF THE BOXES UPON RECEIPT.  
PLEASE VERIFY THE CONTENT OF EACH BOX AGAINST THE LIST OF PARTS**

**Instruction Manual**

Consult with your local governing authority / local municipal codes regarding installation of temporary structures before purchase or assembly. Some jurisdictions may require permits for, or otherwise regulate, installation and use.

**IMPORTANT: RETAIN FOR FUTURE REFERENCE, READ CAREFULLY**

For assistance with assembly, installation, parts, or customer service, contact Gazebo Penguin Customer Service Department at the numbers listed below (English & French, Mon-Fri 8:00 AM to 4:00 PM EST):

**Montreal:** (514) 276-3485

**Elsewhere in Canada and the US:** 1-800-737-7174

**WARNING:**

- For outdoor use.
- Snow should be regularly cleared from the roof and not allowed to accumulate.
- Retain your **proof of purchase** for warranty purposes. Also keep the **original boxes** until the installation is complete and correct.
- The unit may take more than 4 hours and 3 people are required for this assembly.



**PRIOR TO ASSEMBLY:**

- Please don't destroy boxes until completely assembled.
- The foundation must be level, flat, and solid, such as concrete or asphalt.
- Keep away from overhead utility lines, tree branches, and other structures.
- Check for underground pipes or wires if digging or drilling is required.
- Do not install near roof lines or other structures that could shed snow, ice, or excessive rain run-off onto the roof top.
- Assemble the structure as close to its final location as possible.
- It is recommended to wear safety gloves, safety glasses, and hard hats for installation.
- Do not hang from, climb on, or stand on the structure or roof.
- Before assembly, read instructions and check that all parts are present in the boxes. If any parts are missing, refer to warranty information.
- A 6ft (1.8m) stepladder, Phillips screwdriver, tape measure, level, mallet, and a tarp to place parts on will be required for assembly (not included).
- Remove top protective film from roof panels prior to assembly; DO NOT remove bottom protective film until ready to insert roof panels, so as to identify which side is on top.

**ANCHORING INSTRUCTIONS:**

- Proper anchoring of the frame to the base and the wall is required for safety.
- Any structure not anchored securely has the potential to fly away during high wind causing damage and safety hazard.
- How the item is anchored, and the hardware and tools required, will vary based upon the set up location and are not provided.
- Please check with your local hardware store if for the appropriate anchors for your surface.
- Do not anchor to pavers / pavement slabs because they are not a solid foundation.
- Periodically check the anchors to ensure they remain secure

**CARE AND MAINTENANCE:**

- In case of a defective or damaged part, or for any other questions concerning the product, please contact the manufacturer directly.
- Please have the parts list and part numbers on hand when ordering or requesting replacement parts.











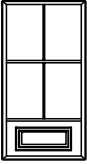
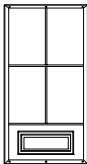
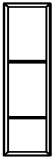
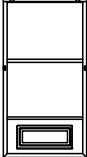
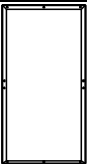

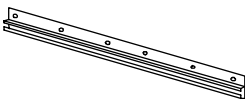
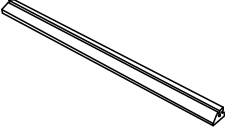
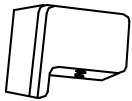
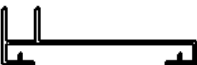

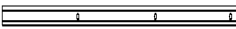
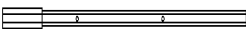



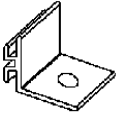
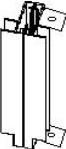
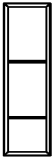
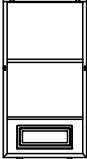
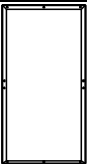

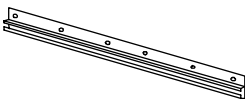
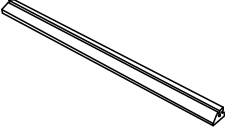
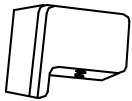
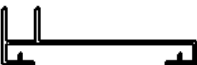

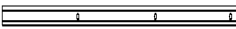
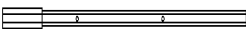



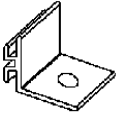
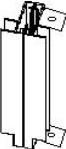

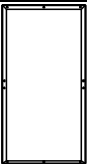

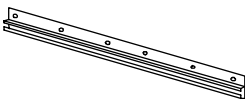
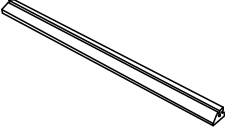
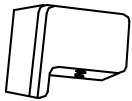
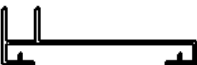

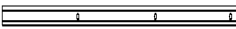
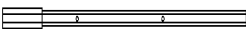

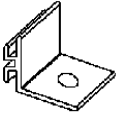
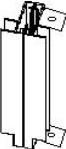

**ROOF PANELS:**

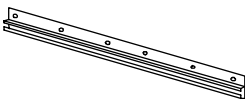
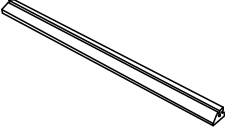
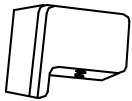
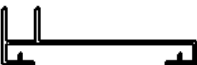

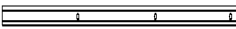
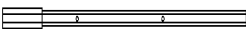



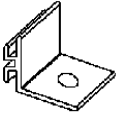
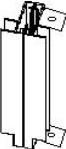



- Gently clean with an environmentally-friendly soap solution and water using a sponge or washcloth.
- Do not use abrasive materials, wire brushes, chemicals, harsh cleaners, or bleach.
- Rinse using a garden hose and air dry. If removed, ensure thoroughly dry prior to storage.
- Do not use pressure washer.





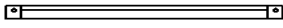
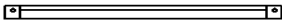
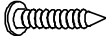
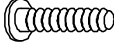
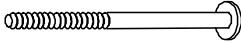
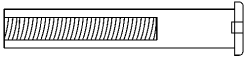
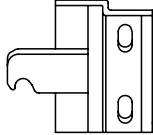
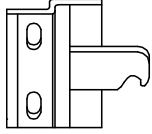
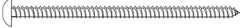
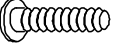



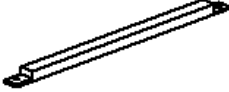

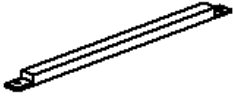
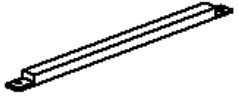
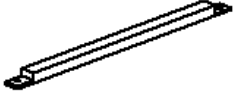

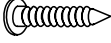

**STRUCTURE:**

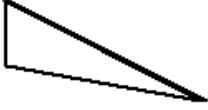
- Gently clean with an environmentally-friendly soap solution and water using a sponge or washcloth.
- Do not use abrasive materials, wire brushes, chemicals, harsh cleaners, or bleach.
- Rinse using a garden hose and air dry.
- Do not use pressure washer.
- If there are nicks, chips, and/or scratches see the part # of the paint in the parts list to obtain a matching touch-up paint.

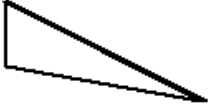
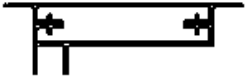
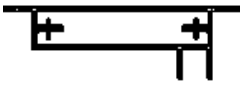
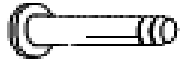
## SOLARIUM W1209 1/2

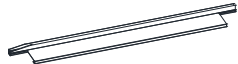

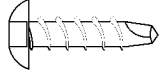





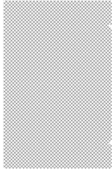
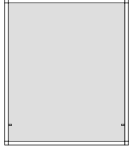

DESCRIPTION	PACKED IN BOX	QTY	DRAWING	DESCRIPTION	PACKED IN BOX	QTY	DRAWING																																																																												
10-496-12 REGULAR FRAME A-3	2	2		10-497-12 FRAME NEXT TO DOOR B-3 (Has more holes)	2	1																																																																													
	3	1			3	1		12-141-12 HALF FRAME A-3 1/2	2	1		10-498-12 SLIDING DOOR C-3	2	1		3	1	3	1	10-499-12 SLIDING DOOR FRAME D-3	2	1		11-544-12 CONNECTING PIECE E-3	4	12		3	1	4	12	11-545-12 TOP DOOR RAIL F-3	4	2		11-546-12 BOTTOM DOOR RAIL G-3	4	2		08-138-12 PLASTIC STOPPER H-3	5	4		12-142-12 LEFT SIDE RECEIVER I-3	4	1		12-143-12 RIGHT SIDE RECEIVER J-3	4	1		10-502-12 CORNER CONNECTOR K-3	4	2		12-155-12 LEFT CROSSBEAM L-1	4	1		12-156-12 RIGHT CROSSBEAM L-2	4	1		10-503-12 TRACK ML-3	4	1		10-504-12 TRACK MR-3	4	1		10-505-12 TRACK JOINT N-3	5	1		10-506-12 RAFTER BRACKET O-3	5	4		12-007-12 LEFT GABLE JOINT P-3	5	1	
12-141-12 HALF FRAME A-3 1/2	2	1		10-498-12 SLIDING DOOR C-3	2	1																																																																													
	3	1			3	1		10-499-12 SLIDING DOOR FRAME D-3	2	1		11-544-12 CONNECTING PIECE E-3	4	12		3	1	4	12	11-545-12 TOP DOOR RAIL F-3	4	2		11-546-12 BOTTOM DOOR RAIL G-3	4	2		08-138-12 PLASTIC STOPPER H-3	5	4		12-142-12 LEFT SIDE RECEIVER I-3	4	1		12-143-12 RIGHT SIDE RECEIVER J-3	4	1		10-502-12 CORNER CONNECTOR K-3	4	2		12-155-12 LEFT CROSSBEAM L-1	4	1		12-156-12 RIGHT CROSSBEAM L-2	4	1		10-503-12 TRACK ML-3	4	1		10-504-12 TRACK MR-3	4	1		10-505-12 TRACK JOINT N-3	5	1		10-506-12 RAFTER BRACKET O-3	5	4		12-007-12 LEFT GABLE JOINT P-3	5	1		12-008-12 RIGHT GABLE JOINT Q-3	5	1									
10-499-12 SLIDING DOOR FRAME D-3	2	1		11-544-12 CONNECTING PIECE E-3	4	12																																																																													
	3	1			4	12		11-545-12 TOP DOOR RAIL F-3	4	2		11-546-12 BOTTOM DOOR RAIL G-3	4	2		08-138-12 PLASTIC STOPPER H-3	5	4		12-142-12 LEFT SIDE RECEIVER I-3	4	1		12-143-12 RIGHT SIDE RECEIVER J-3	4	1		10-502-12 CORNER CONNECTOR K-3	4	2		12-155-12 LEFT CROSSBEAM L-1	4	1		12-156-12 RIGHT CROSSBEAM L-2	4	1		10-503-12 TRACK ML-3	4	1		10-504-12 TRACK MR-3	4	1		10-505-12 TRACK JOINT N-3	5	1		10-506-12 RAFTER BRACKET O-3	5	4		12-007-12 LEFT GABLE JOINT P-3	5	1		12-008-12 RIGHT GABLE JOINT Q-3	5	1																					
11-545-12 TOP DOOR RAIL F-3	4	2		11-546-12 BOTTOM DOOR RAIL G-3	4	2																																																																													
08-138-12 PLASTIC STOPPER H-3	5	4		12-142-12 LEFT SIDE RECEIVER I-3	4	1																																																																													
12-143-12 RIGHT SIDE RECEIVER J-3	4	1		10-502-12 CORNER CONNECTOR K-3	4	2																																																																													
12-155-12 LEFT CROSSBEAM L-1	4	1		12-156-12 RIGHT CROSSBEAM L-2	4	1																																																																													
10-503-12 TRACK ML-3	4	1		10-504-12 TRACK MR-3	4	1																																																																													
10-505-12 TRACK JOINT N-3	5	1		10-506-12 RAFTER BRACKET O-3	5	4																																																																													
12-007-12 LEFT GABLE JOINT P-3	5	1		12-008-12 RIGHT GABLE JOINT Q-3	5	1																																																																													

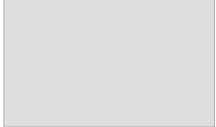
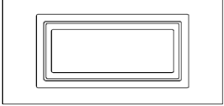
DESCRIPTION	PACKED IN BOX	QTY	DRAWING	DESCRIPTION	PACKED IN BOX	QTY	DRAWING
10-509-12 ROOF RAFTER CAP R-3	5	7		12-146-12 LEFT SIDE RAFTER S-3	4	1	
12-147-12 RIGHT SIDE RAFTER T-3	4	1		12-148-12 REGULAR RAFTER U-3	4	5	
10-513-12 MIDDLE ROOF JOINT V-3	5	2		10-514-12 MIDDLE ROOF JOINT W-3	5	4	
10-515-12 EDGING X-3	5	2		10-516-12 EDGING Y-3	5	4	
08-156-12 SCREW Z-3	5	10	 (M4*16mm)	08-158-12 BOLT Bb-3	5	28	 (M6*16mm)
08-161-12 BOLT Cc-3	5	23	 (M6*73mm)	12-037-12 FEMALE BOLT Cc-3-2	5	12	 M6*60mm
08-169-12 LEFT DOOR LATCH Dd-L-3	5	2		08-165-12 RIGHT DOOR LATCH Dd-R-3	5	2	
08-167-12 SCREW Ee-3	5	10	 (M6*63.5mm)	08-168-12 BOLT Ff-3	5	16	 (M6*12mm)
08-187-12 WASHER Gg-3	5	23		12-161-12 NUT Hh-3-2	5	4	
08-193 PLASTIC PLUG Ii-3	5	10		10-517-12 END ROOF CROSS BAR Jj-3	5	2	

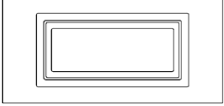
DESCRIPTION	PACKED IN BOX	QTY	DRAWING	DESCRIPTION	PACKED IN BOX	QTY	DRAWING
10-518-12 REGULAR ROOF CROSSBAR Kk-3	5	4		10-519-12 ROOF TOP REINFORCE LI-3	5	2	
10-520-12 ROOF TOP REINFORCE Mm-3	5	4		08-134-12 UPPER DOOR RAIL END CAP Nn	5	4	
08-135-12 SCREW Oo-3	5	8	 (M4*12mm)	12-149 (63 1/4 x 24 1/2") LEFT+RIGHT ROOF PANEL Pp-3	1	4	
12-150 (63 1/4 x 23") REGULAR ROOF PANEL Qq-3	1	8		12-151 LEFT BACK GABLE PANEL Rr-3	1	1	
12-152 LEFT FRONT GABLE PANEL Ss-3	1	1		12-153 RIGHT BACK GABLE PANEL Tt-3	1	1	
12-154 RIGHT FRONT GABLE PANEL Uu-3	1	1		10-527-12 LEFT WALL GUIDE Vv-3	4	1	
10-528-12 RIGHT WALL GUIDE Ww-3	4	1		10-529-12 SCREW FOR FIXING TO WALL Xx-3	5	18	
10-530-12 REGULAR TOP FILLER Yy-3	5	4		10-531-L-12 END TOP FILLER Zz-3-L	5	1	
12-047-12 BOLT Ww	5	12	 M5*15	13-045-12 SELF- TAPPING SCREW PQ-3	5	4	
10-531-R-12 END TOP FILLER Zz-3-R	5	1		23-007-12 PLASTIC PLUG Kk	5	4	

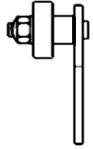
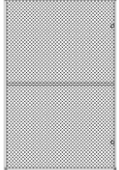
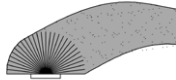

**AVAILABLE REPLACEMENT PARTS**

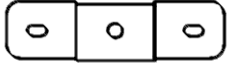
DESCRIPTION	DRAWING	DESCRIPTION	DRAWING
10-435-12 PVC WINDOW (in frame)		85-014 REPLACEMENT SCREENING (no frame)	
12-176-12 PVC WINDOW for HALF FRAME A-3 1/2		85-417-S ROUND SPLINE FOR SCREENING	
10-493 PVC WINDOW (replacement material only)		11-824-12 BOTTOM PLASTIC PANEL (for wall panels)	
85-417-P ROUND SPLINE FOR PVC WINDOW		11-825-12 BOTTOM PLASTIC PANEL (for doors)	
15-123-12 PIN FOR PVC WINDOW		12-173-12 BOTTOM PLASTIC PANEL FOR HALF FRAME A-3 1/2	
13-055 PC WINDOW (for sliding door)		15-097-12 DOOR WHEEL ASSEMBLY	
12-174-12 MOSQUITO SCREEN (in frame)		10-458 REPLACEMENT WEATHERSTRIP 124"	
12-175-12 MOSQUITO SCREEN FOR HALF FRAME A-3 1/2		15-125-12 MOUNTING BRACKET FOR RAFTER (U-3)	

**\*NOT INCLUDED IN THE BOX**

DESCRIPTION	COLOUR	PART #
SPRAY PAINT	SAND	11-699
PAINT PEN		18-245

REMOVE STICKER AFTER ASSEMBLY

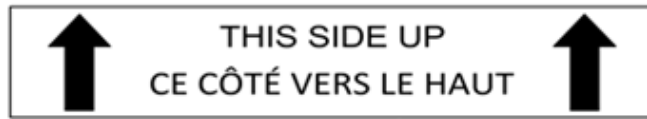

D-3 FRAME

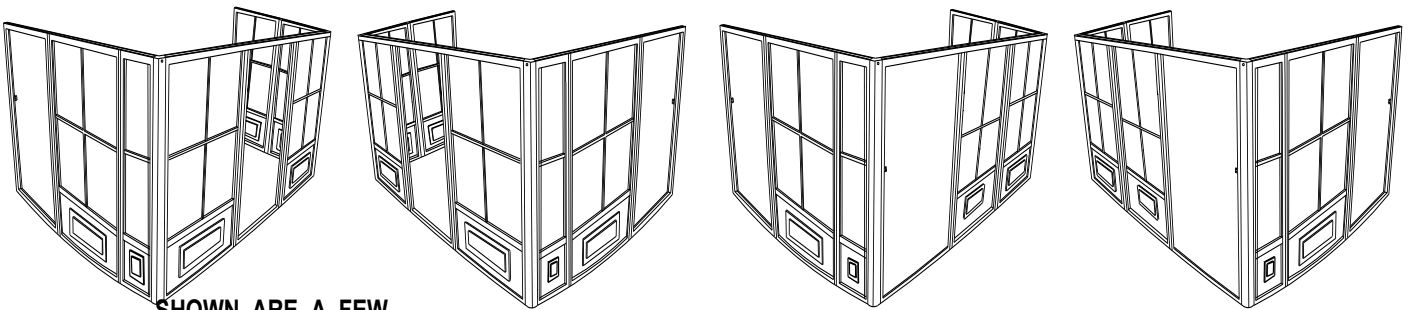

**SHOWN ARE A FEW  
POSSIBILITIES**

THE SLIDING DOOR CAN BE PLACED IN ANY LOCATION  
AS LONG AS THE FRAME NEXT TO DOOR IS BESIDE IT.

LA PORTE COULISSANTE PEUT ETRE PLACÉE N'IMPORTE OÙ  
TANT QUE CADRE ADJACENT À LA PORTE EXT À CÔTÉ DE LA  
PORTE.

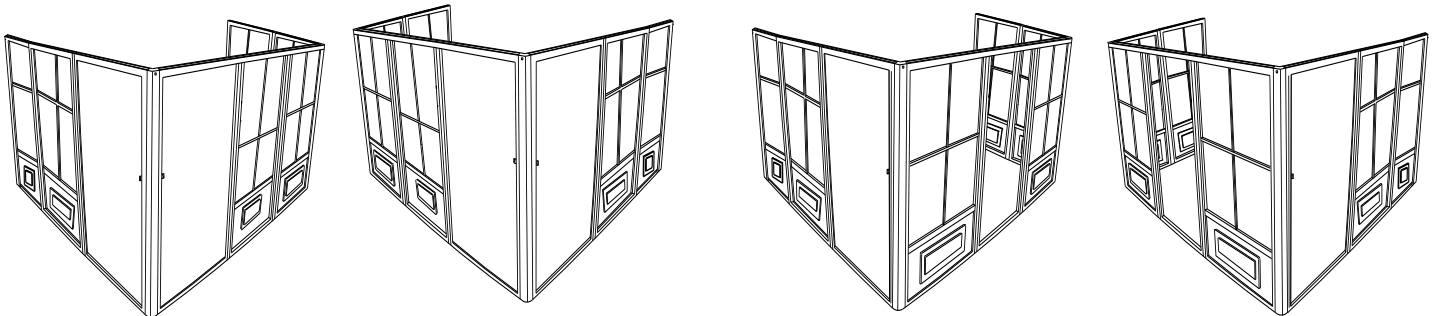

**TOOLS REQUIRED:** Screwdriver, Knife, File (smooth), Needle-nosed pliers, Rubber mallet, Step ladder

(minmum 6' in height), Spatula, Power drill, Tube of silicon, Drill bit 5/16" cement (according to surface)

**BEFORE STARTING:** Ensure that you have a solid base, such as concrete or wooden deck, not slanted more than 1" per 8'. Avoid installing unit adjacent to trees or a sloped roof, as snow and ice may slide onto the solarium and cause it to collapse. **Please don't destroy boxes until completely assembled.**

### STEP #1

**Decide the position of the door frames before assembly according to where you intend to slide the door.** At the front of the solarium, use frame D3 for the opening of the door and B3 for the direction of the door when open. Ensure frames A-3 1/2 are on the sides. Use E3 between frame ends and use two K3 joints for corners. Look for the sticker on the door frame D3 that indicates which side is upward. **(See sketch on previous page)**

#### NOTE:

When placing the door frame opening, make sure the inserts on the frame are on the inside and on the upper half of the frame of the solarium because the door will be set on the inside due to clearance.

**NOTE:** When sliding the connectors, shake the frame so that they will slide easily. Do not use tools to force. If needed, clean the paint with a file and make sure the ends of the frame and joints are not bent or warped. If so, use the needle-nosed pliers to straighten or a file to make them slide easily.

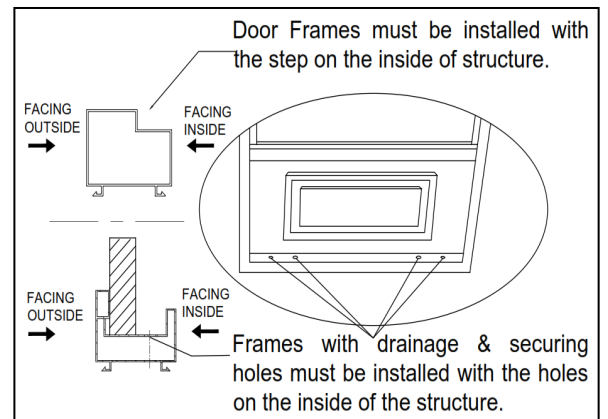
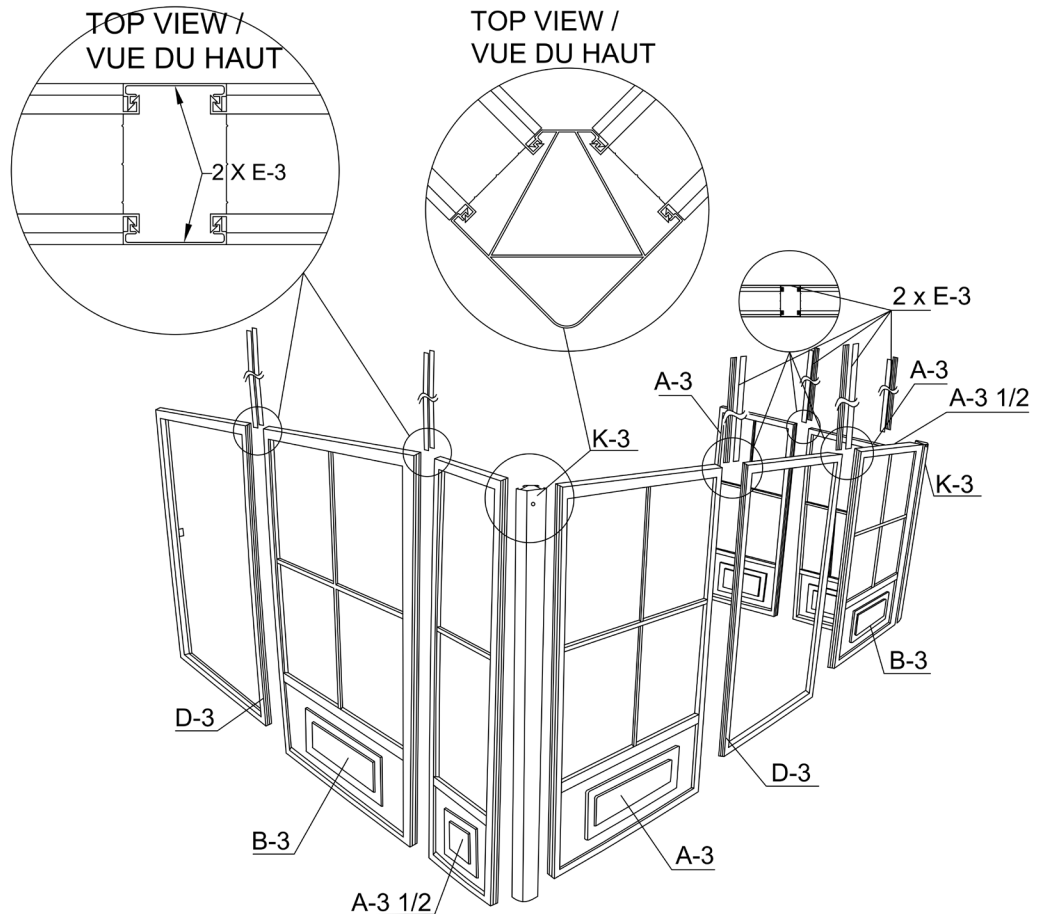

### STEP #2

Slide the vertical guides Vv-3 left and Ww-3 right into the 2 ends of the frames along the grooves, shaking while sliding for easier movement. Next, slide two (2) Yy-3 and one (1) Zz-3 from left side to right on top of the frame. The groove should be towards the interior of the unit. Repeat from right side with two (2) YY-3 and one (1) Zz-3 and space evenly.

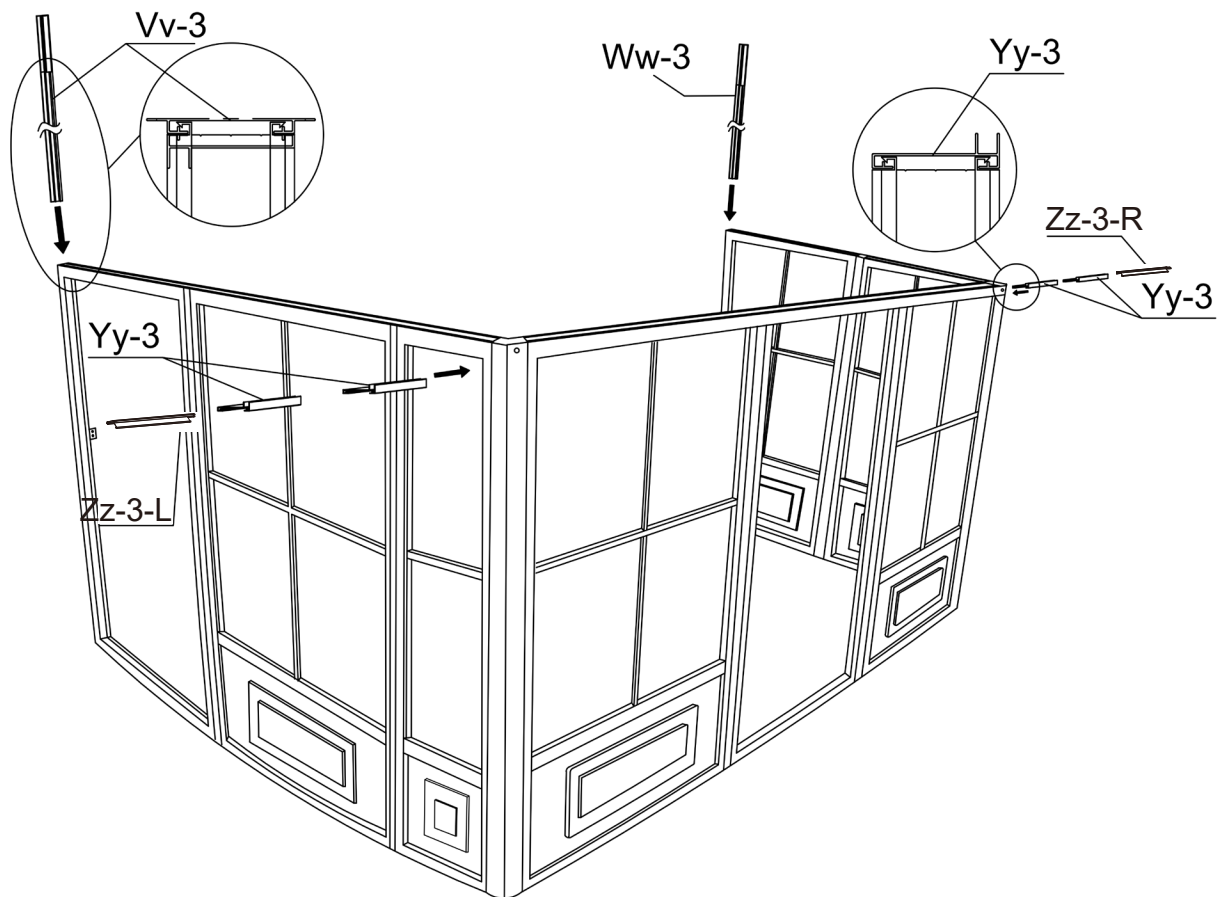
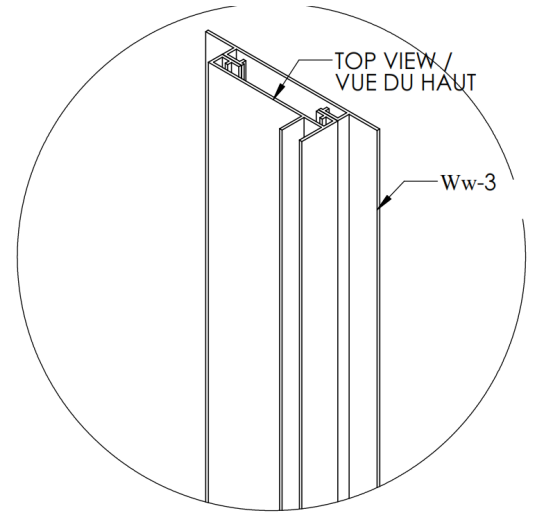
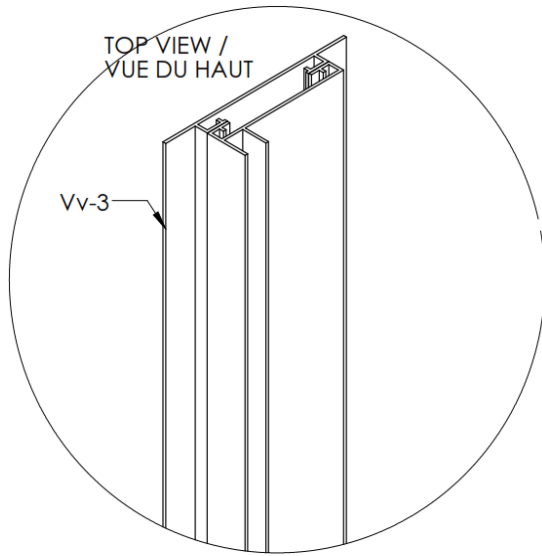

### **STEP #3**

Slide brackets O-3 into ML-3 and MR-3 in equal quantity. Then join ML-3 and MR-3 using N-3. Once assembled lift the assembled wall track and position it above the vertical wall guides Vv-3 and Ww-3 (approximate 96" from the ground). Secure the wall track (ML-3, MR-3) and vertical wall guides (Vv-3 and Ww-3) to the wall by drilling holes through the aluminum, at

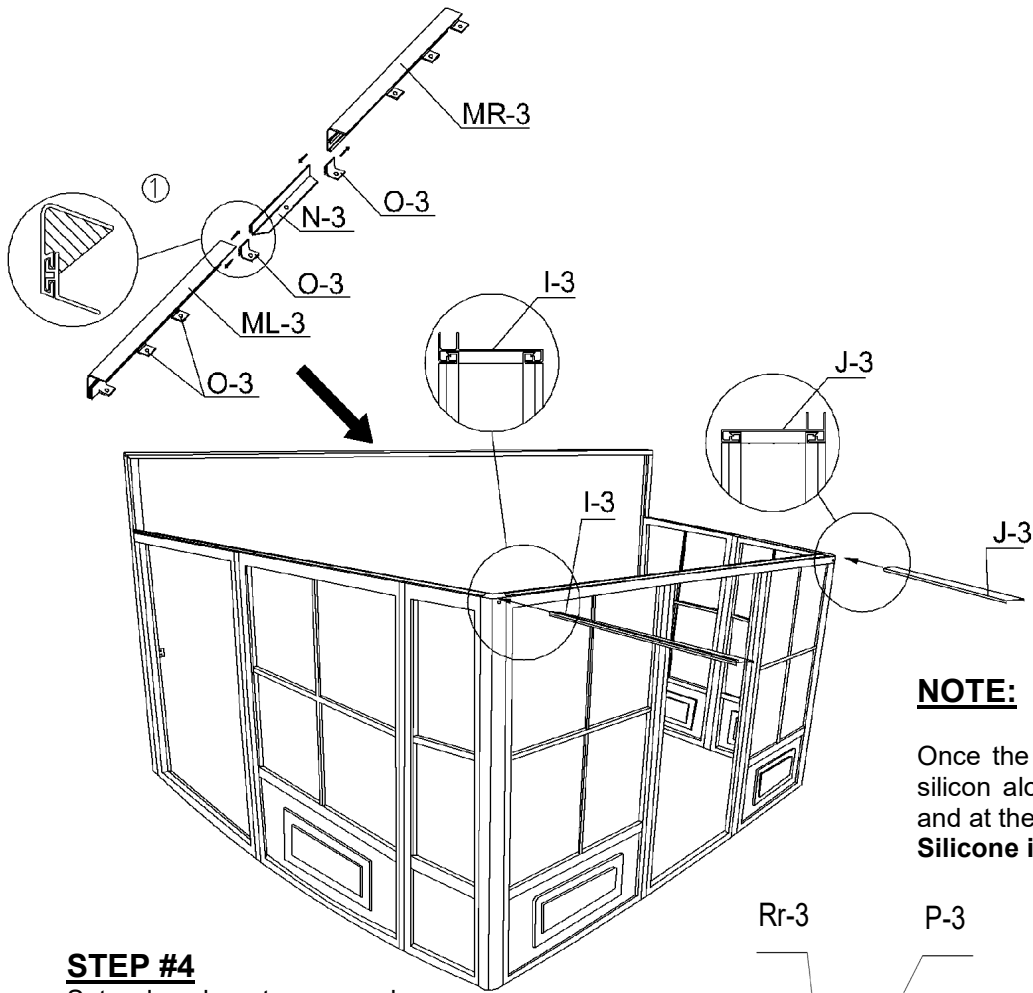

**NOTE:**

Once the wall track is in place, apply silicon along the top of the wall track and at the joint of the two tracks.  
**Silicone is not supplied.**

**STEP #4**

Set polycarbonate exposed side on the outside over horizontal left guide I-3, use one (1) Rr-3 panel, one (1) P-3 joint and one (1) Ss-3 panel, then do the right side with one (1) Tt-3 panel, one (1) Q-3 joint and one (1) Uu-3 panel over the J-3 horizontal panel. Secure P-3 and Q-3 to I-3 and J-3 respectively with self-tapping screws (PQ-3).

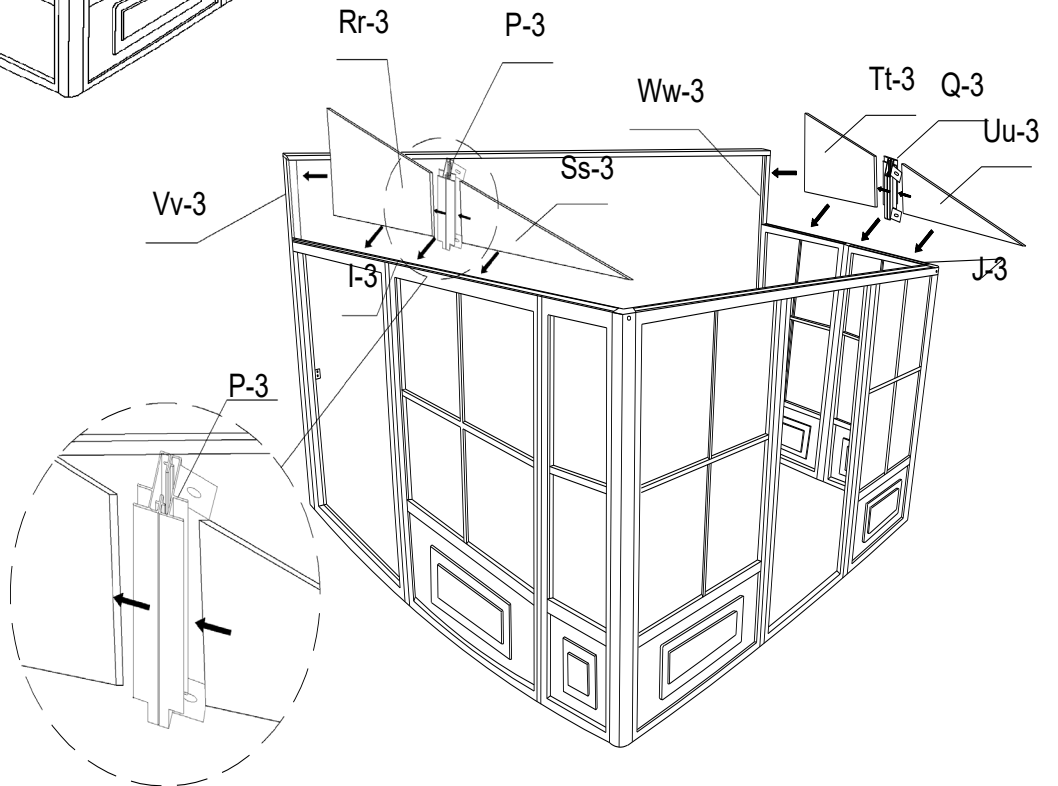

## **STEP #5**

Set right rafter T-3 over last bracket then secure it with Bb-3 screw and continue screwing through joint K-3 with the Bb-3 screw. Secure to Q-3 bracket with self-tapping screw (PQ-3). Repeat on left side with rafter S-3.

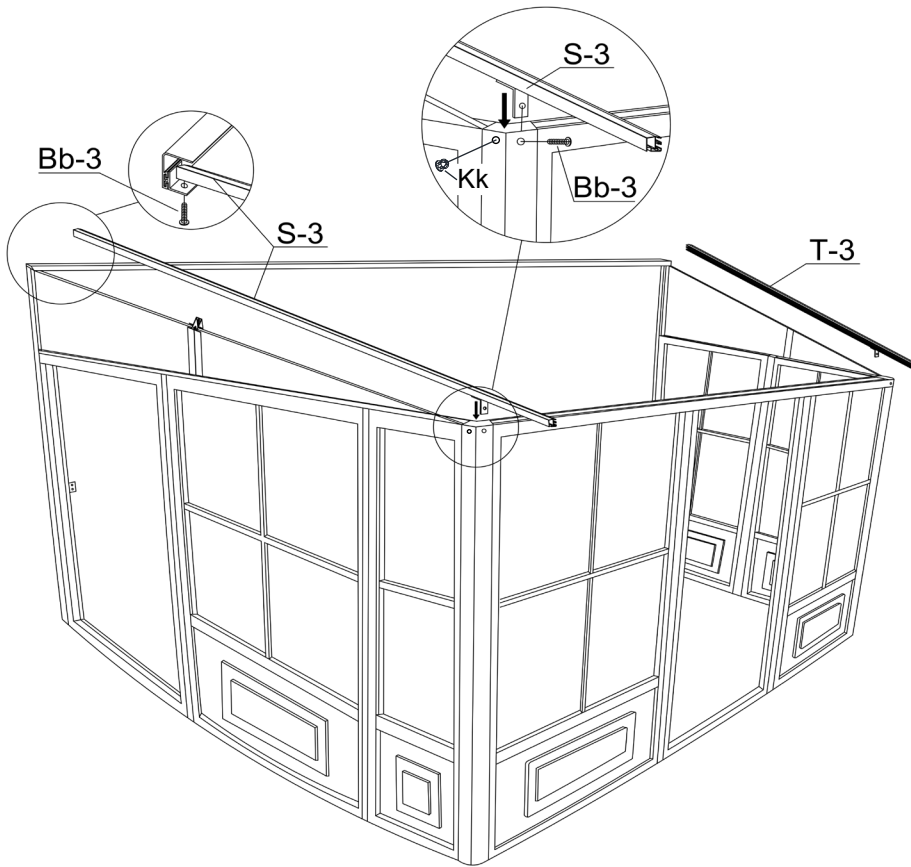

## **STEP #6**

**DOOR UNIT(S) MUST BE ASSEMBLED INSIDE OF SOLARIUM.**

Slide upper door track F-3 into wheels of sliding door C-3. Slide lower door track G-3 and make sure inserts are close enough to the frame to attach. Use bolt Bb-3 to affix the plastic stopper H-3 on each end of top door rail F-3. Use Oo-3 screws to affix upper door rail and cap Nn-3, at each end of top rail door.

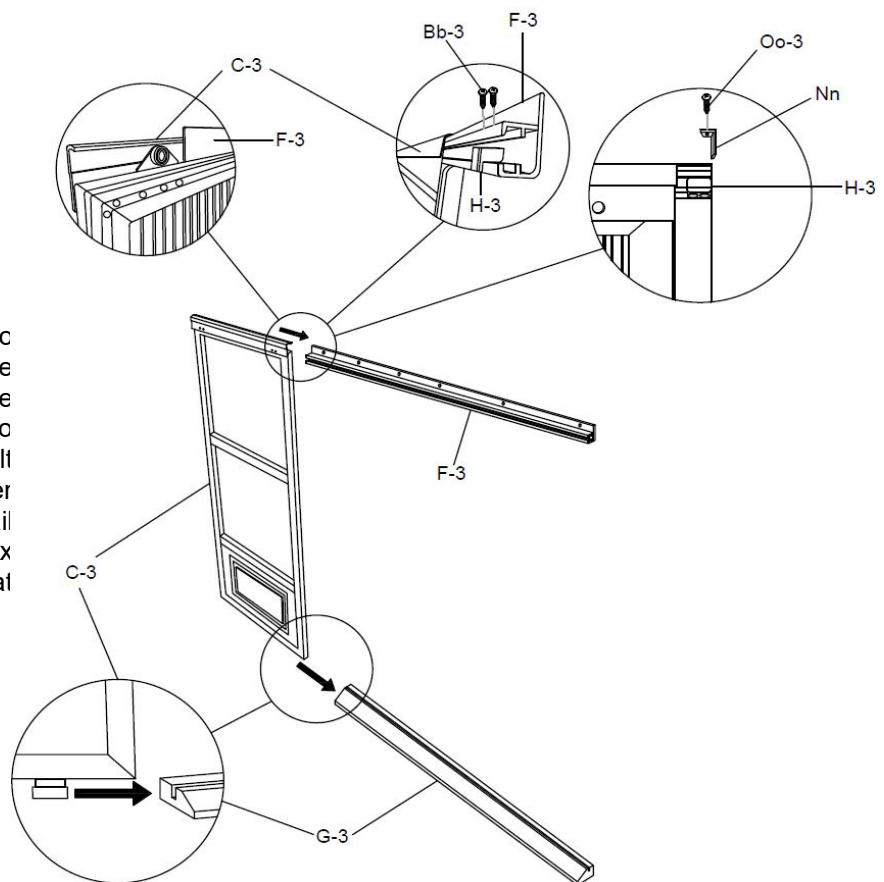

## **STEP #7**

Lift up door and track inside of solarium then set it over the door opening by screwing at the top. First use bolts (Ww) and washers (Gg-3) on the inside and female bolts (Cc-3-2) on the outside for the top assembly. See diagram below. Attach lower track with bolts (Cc-3) and washers (Gg-3). Set up door latch on the side required for your door to lock, adjust latch as required.

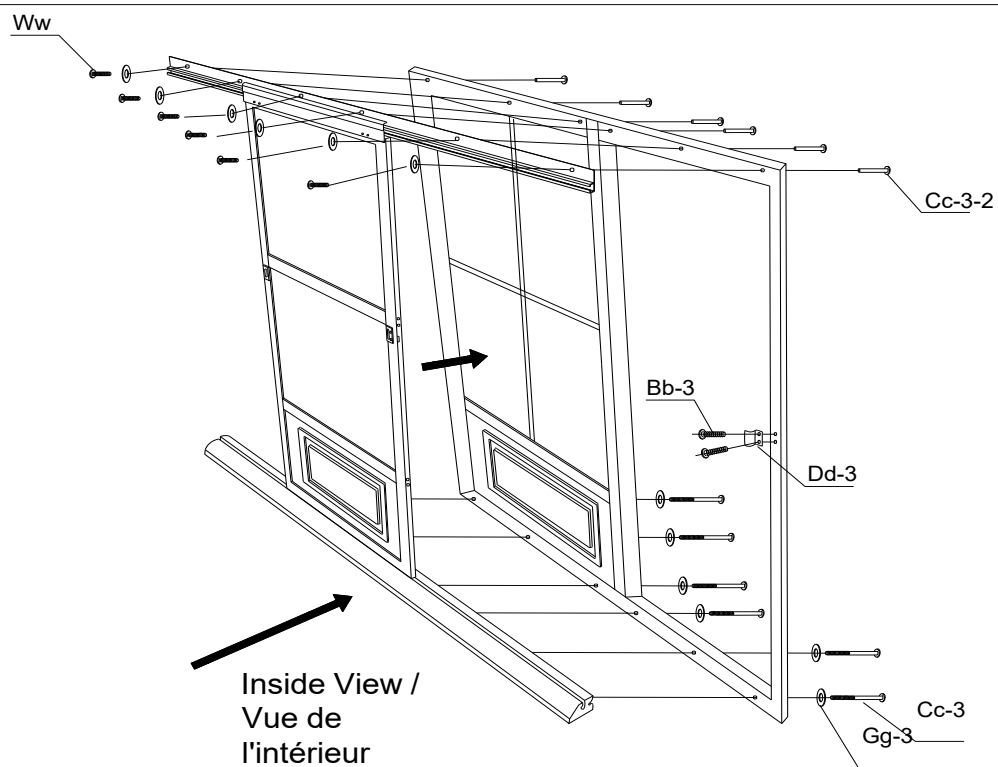
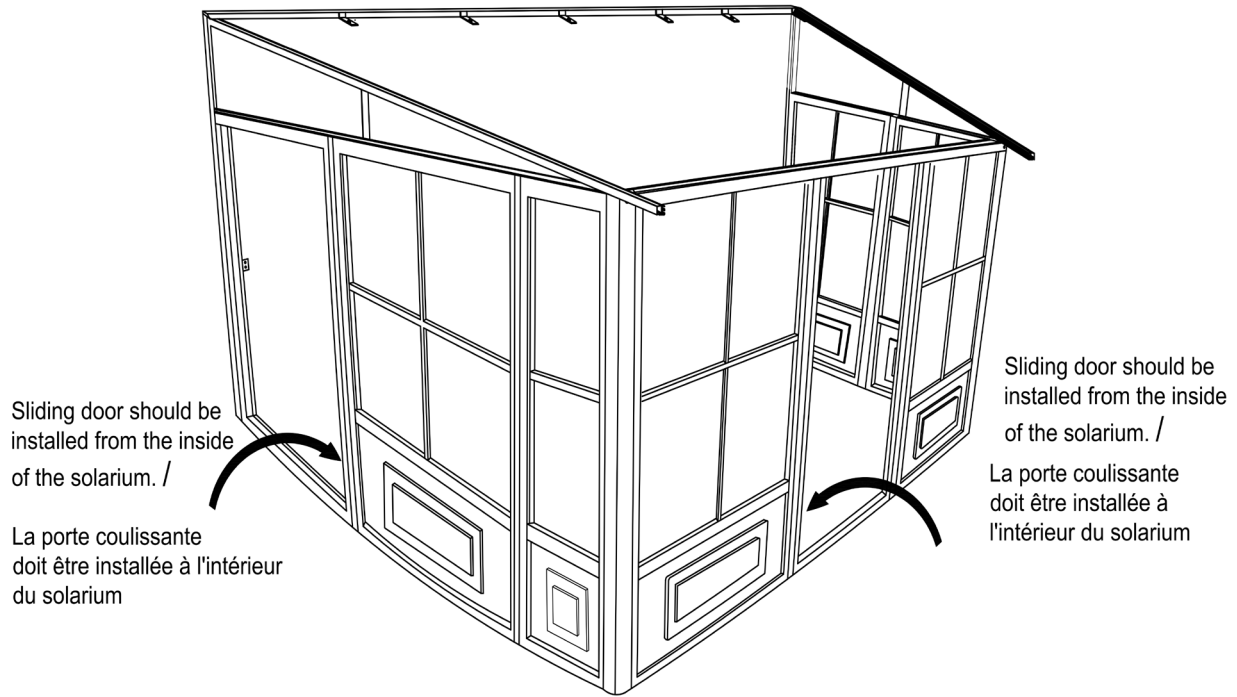

## **STEP #8**

Set U-3 rafters over the middle of each panel with Bb-3 screws at the top and two (2) Z-3 screws over the brackets on frame manually. Set U-3 rafter on each joint and use Z-3 screws manually. Do not use power drill. If necessary, make a Pilot Hole 1/8".

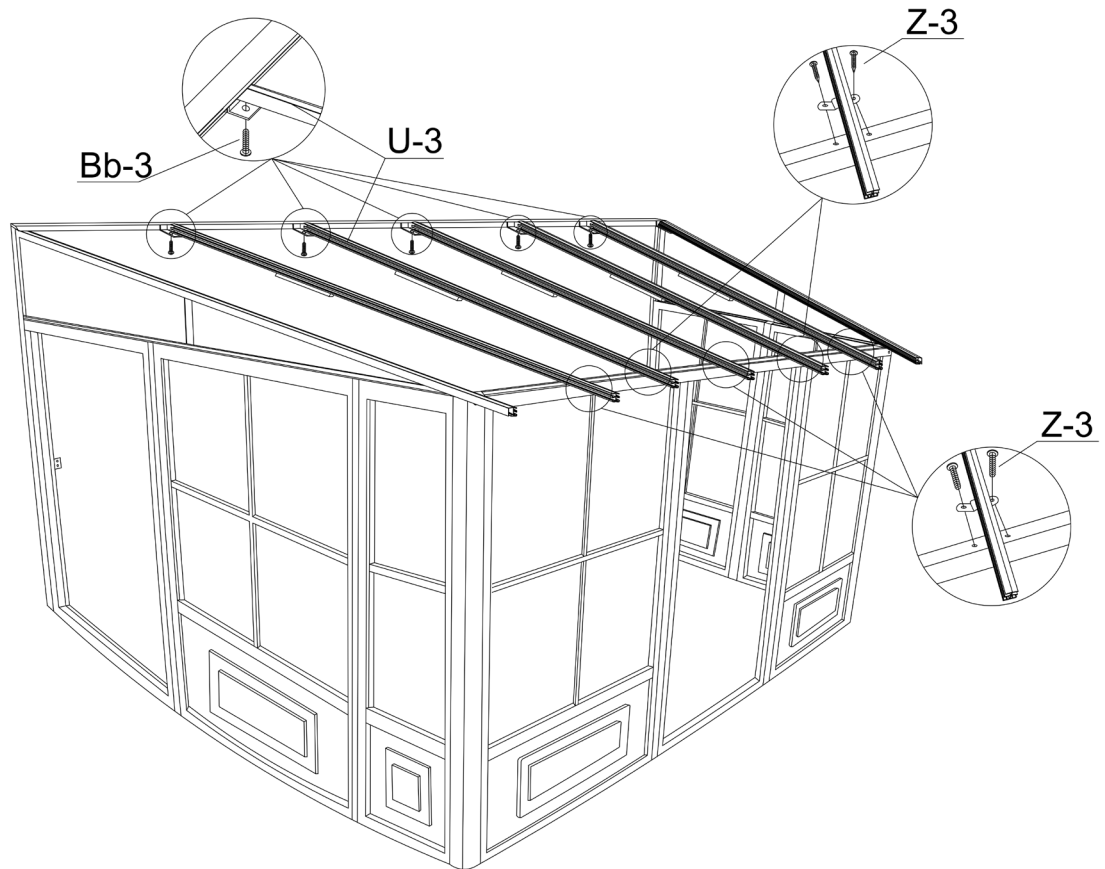

3

## **STEP #9**

Remove protective film from two (2) sides of each panel and make sure the top side of the panel faces the sunlight. Insert and slide on the top groove of the rafters all the way to the end. Pp-3 should go first and last with the Qq-3 panels in between.

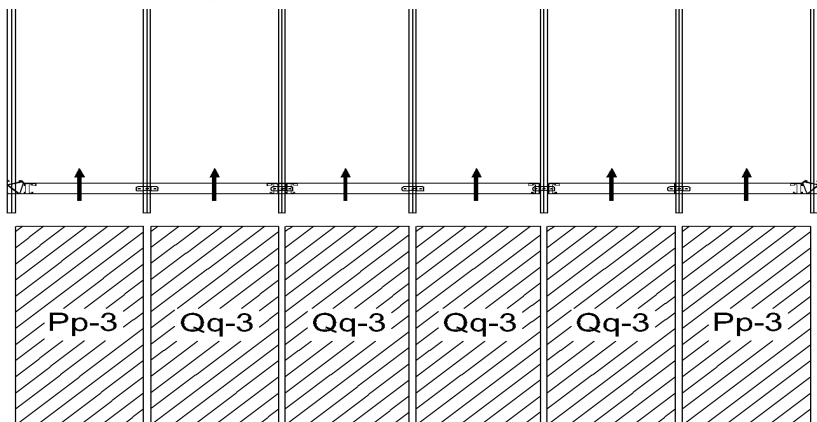



## STEP #10

Insert the aluminum middle roof joint between the rafters, making sure the slotted holes are at the bottom. Slide into upper and lower grooves of the rafters then slide all the way into the panels. Make sure the panels are inside the aluminum middle roof joint groove. Insert a V-3 at either end, then insert all W-3 and then the remaining V-3. Tap gently with rubber mallet if needed.

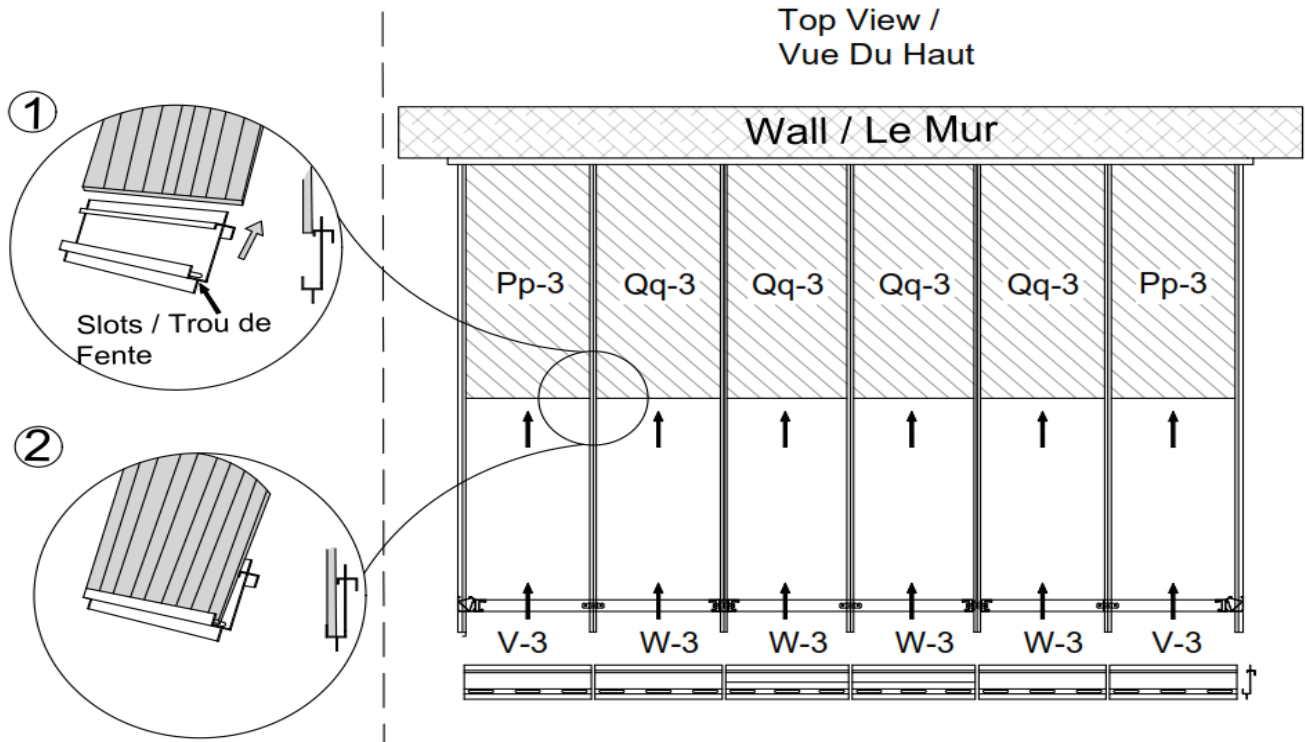

## STEP #11

Insert the second row of panels into the lower groove on the rafter. Slide panels until they reach the aluminum pieces between the panels and gently tap on the panel to guide it into the aluminum groove. Use a spatula if needed to make it fit. Insert two (2) Pp-3 on either end, then insert the Qq-3 panels.

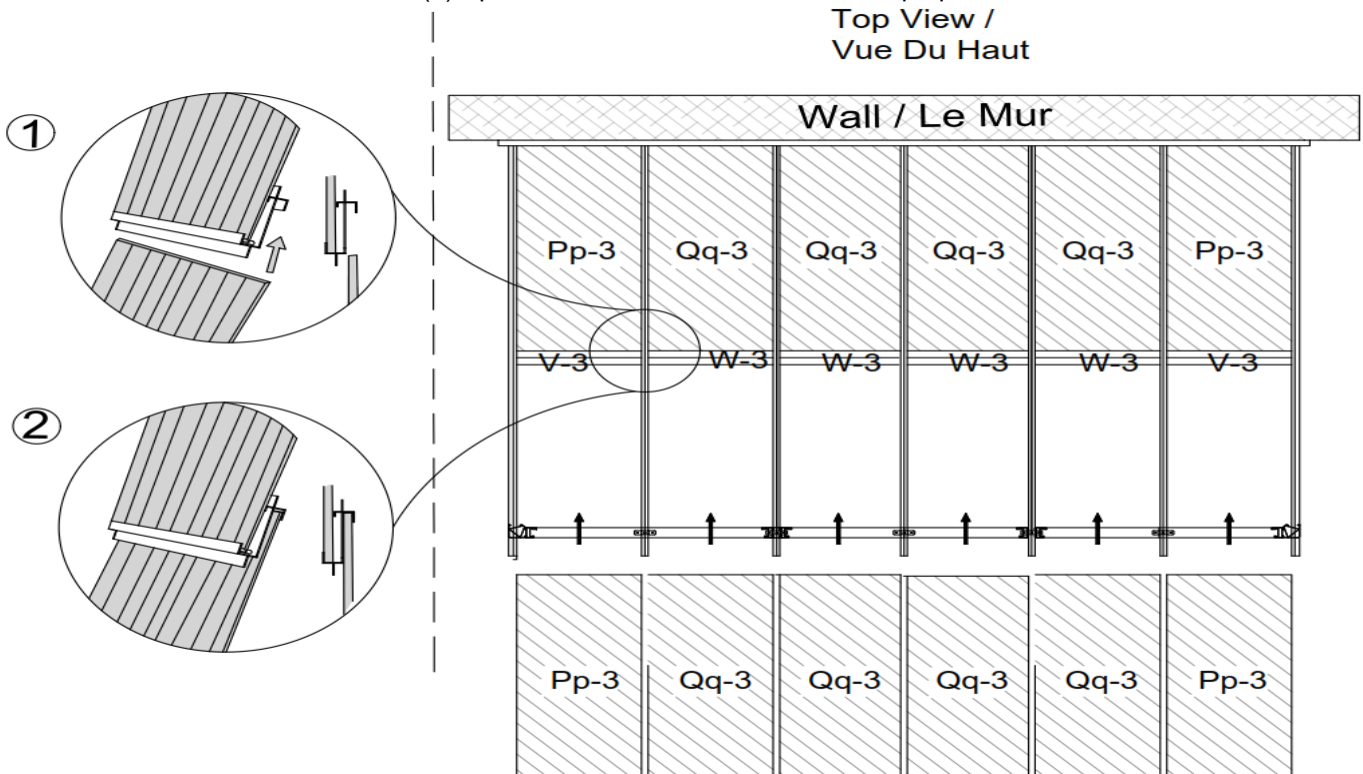

## **STEP #12**

Starting at either end, add X-3 edging and one (1) R-3 bracket and screw with Bb-3 manually, do not use power drill. Add Y-3 edging and repeat until you reach the end, then add the X-3 edging.

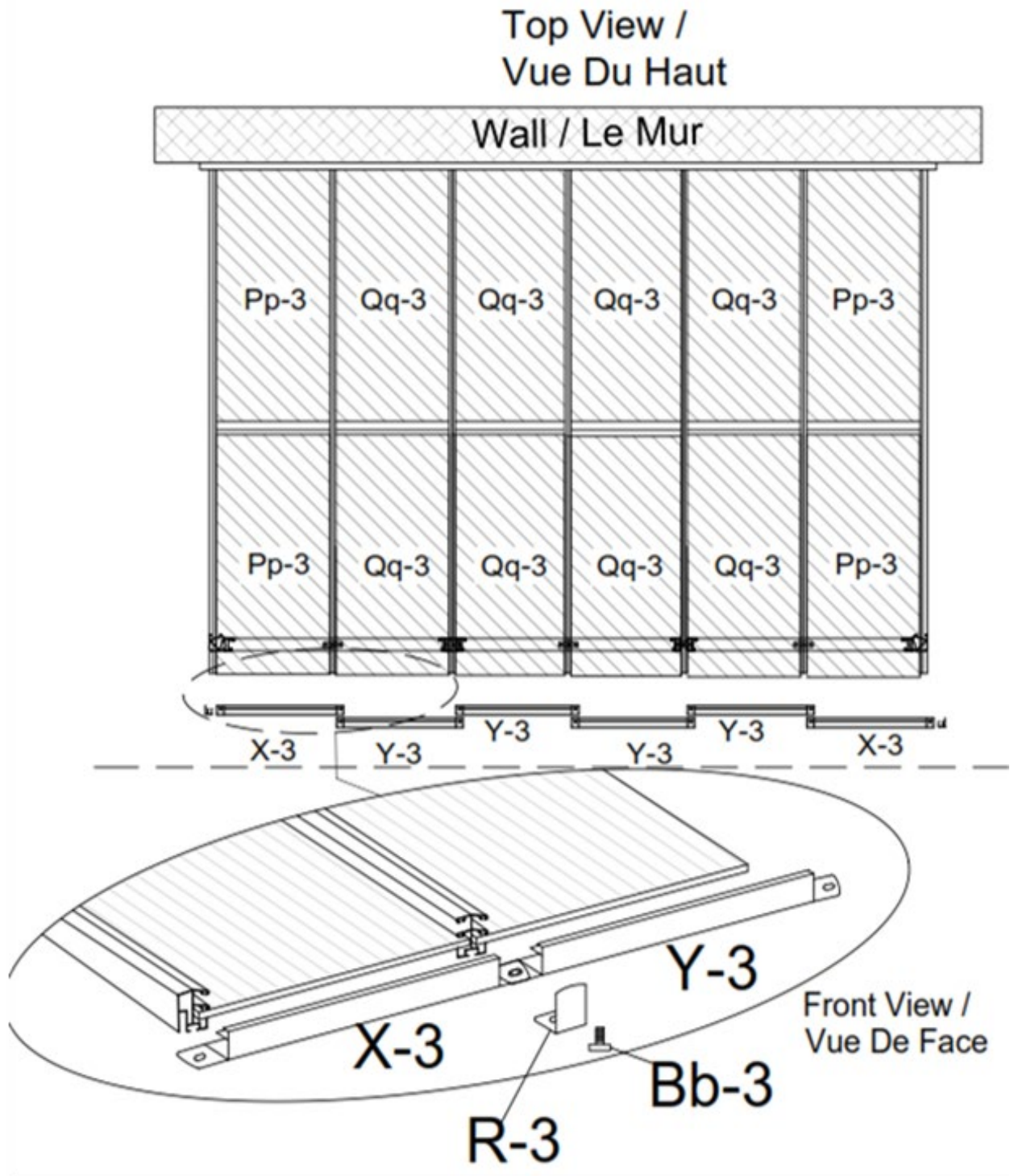

### **STEP #13**

On the inside of the solarium under each rafter there are two rows of inserts with threads, and one crossbeam in two pieces. Start the upper row with a Jj-3 at either end and Kk-3 between panels, screwing them in place with Ff-3. Use Ff-3 screws for the lower row LI-3 at the 2 ends and Mm-3 between panels. Lastly, assemble crossbeam L-1 and L-2, then secure to rafters using bolts Cc-3. Make sure screws are manually tight.

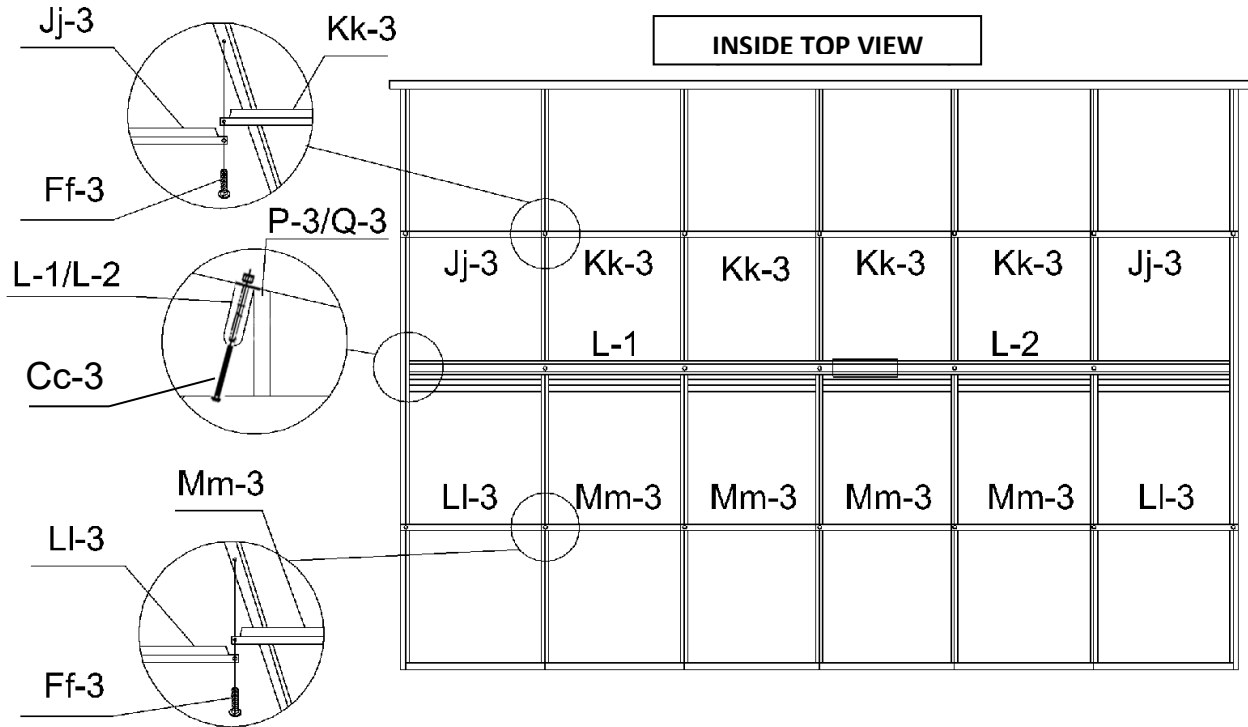

### **STEP #14**

Anchor the solarium to the deck or floor securely using screws and shields supplied. See diagram below.

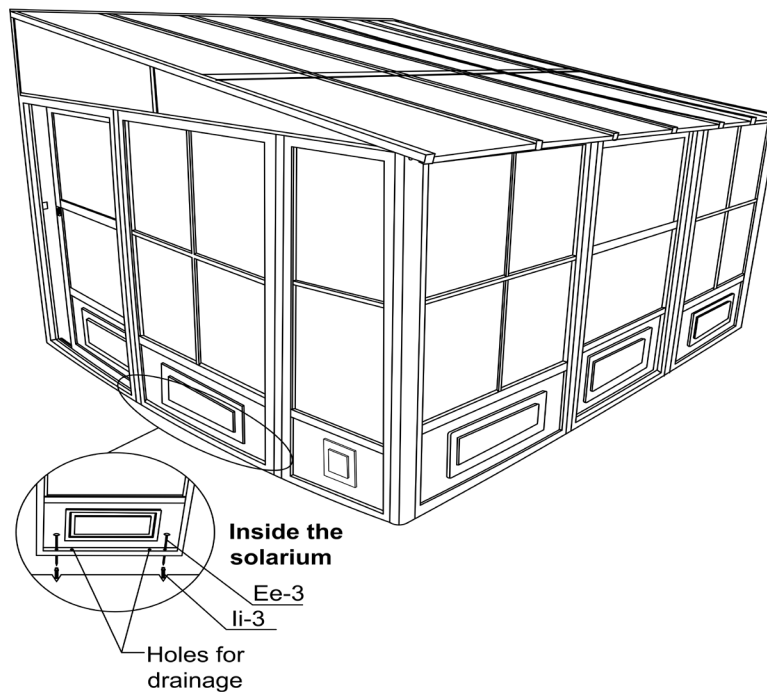

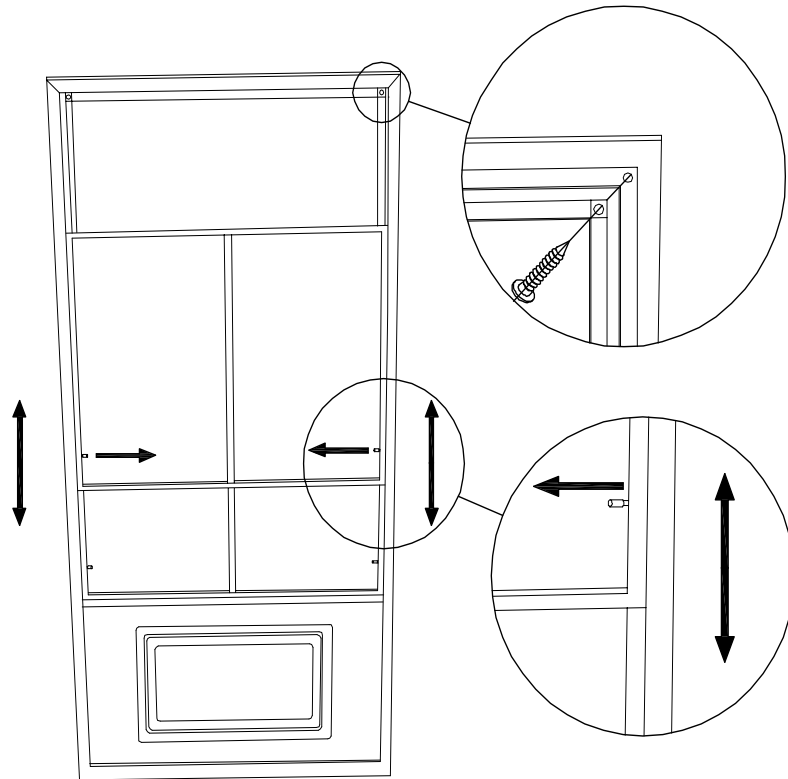

### **SPECIAL NOTES**

To remove a screen, remove the two (2) screws at the top of the frame then pull sideways to the opposite end of the handles to remove. To remove wind panels, push or pull to one side, making sure that locking pin is not locked then remove panels gently, panels are easy to remove.

### **NOTE:**

This unit is not waterproof. For best protection against rain, close the windows of each frame with the outside window in the center, and the inside window at the top.

### **CLEANING INSTRUCTIONS:**

Use only mild or warm soapy water, no strong or abrasive cleaning products. Be sure to remove heavy snow and/or ice.

### **WARNING:**

- 1) Do not use a BBQ or any other flammable product inside the solarium.
- 2) Remove snow from the roof.

**\*Suggestions**

The below mentioned are only suggestions in order to permit drainage, these will vary depending on your flooring – material, flatness and slope.

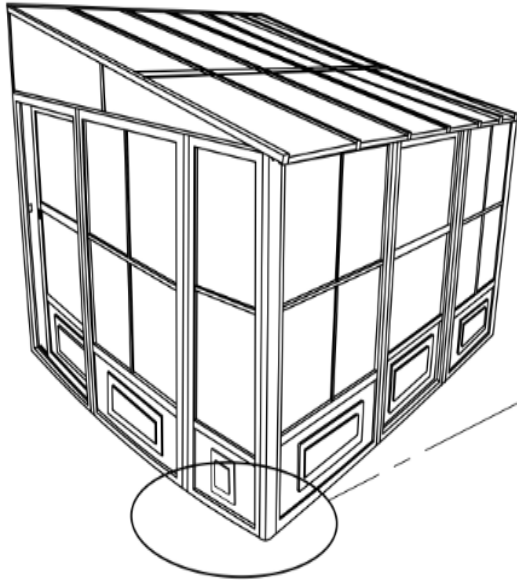

Apply silicone to prevent water from seeping from under the frame /

Appliquez du silicone pour empêcher l'eau de s'infiltrer sous le cadre

**For Concrete Flooring**  
**Pour Sol en Béton**

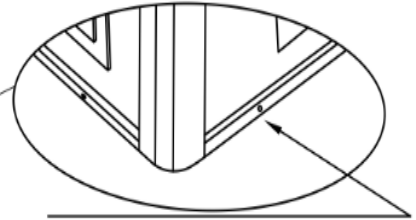

On the outside face, it is suggested to drill holes at the bottom end of the panels to permit drainage when installing on concrete floor /

Sur la face extérieure, il est suggéré de percer des trous à l'extrémité inférieure des panneaux pour permettre le drainage.

**INSIDE VIEW /**  
**VUE DE**  
**L'INTÉRIEUR**

**For Concrete Flooring**  
Seal the provided drain holes on the inside layer

**Pour Sol en Béton**  
Fermer les trous de drainage fournis sur la couche intérieure

**INSIDE VIEW /**  
**VUE DE**  
**L'INTÉRIEUR**

**For Wooden Deck**  
Drill through the wooden deck where drain holes are located to permit drainage

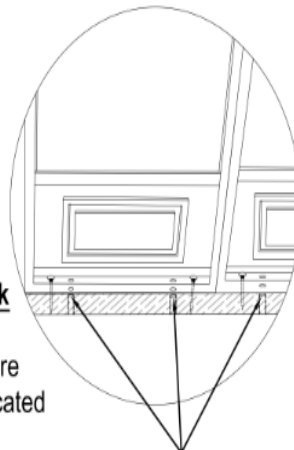

**Pour Deck en Bois**  
Forez les ponts où se trouvent les trous de drainage pour permettre de l'eau passer à travers.

Note: The Dimensions are approximate.

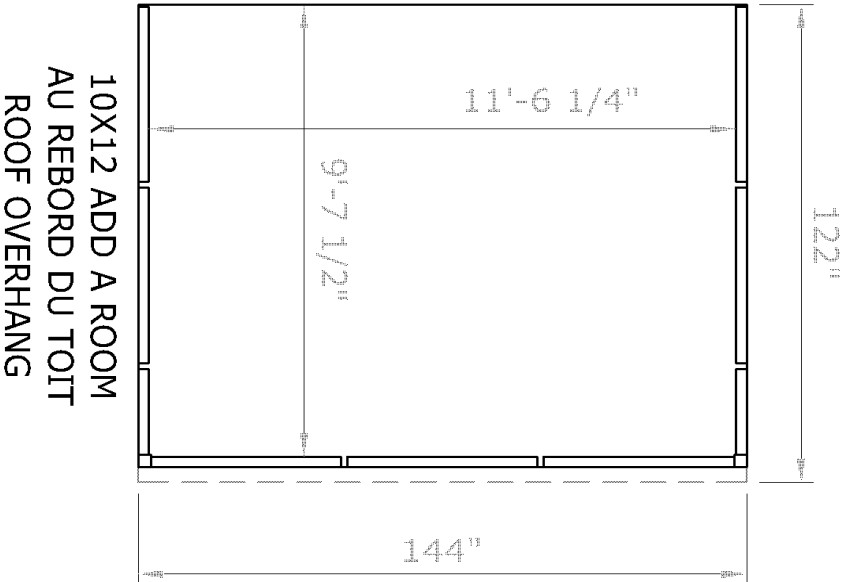
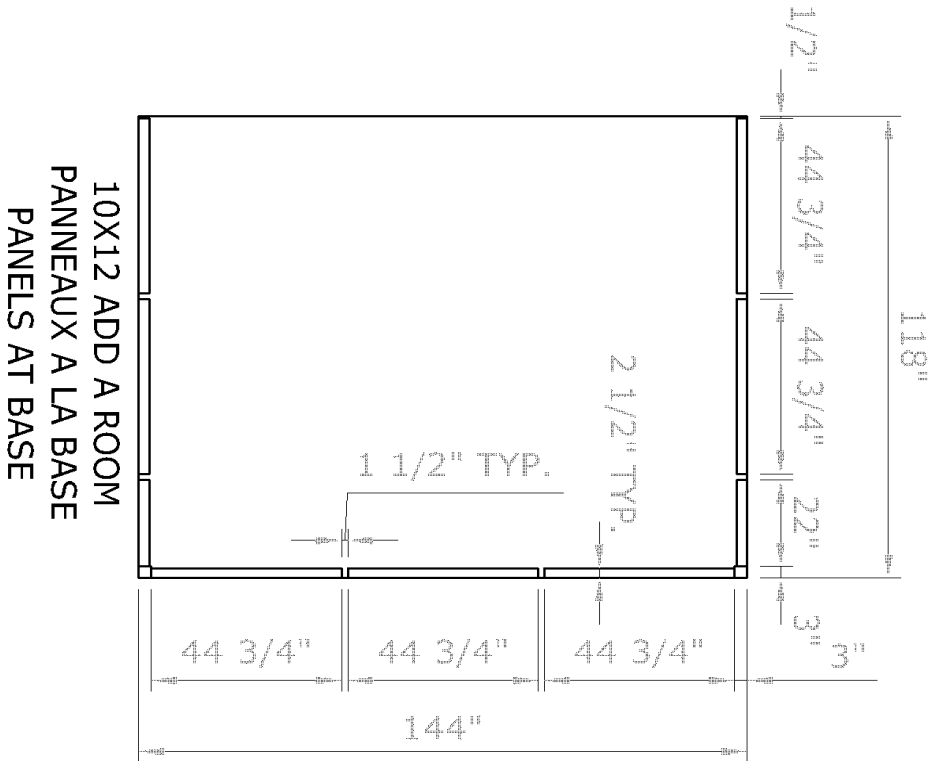

# WARRANTY

---

Carefully inspect the contents of the package to check if any components are missing or damaged. In the event that any parts are missing or damaged, **do not return the product to the place of purchase; instead, contact Gazebo Penguin's Customer Experience Department.**

**Montreal: (514) 276-5643**

**Elsewhere in Canada and the United States: 1-800-737-7174**

**info@gazebopenguin.com**

This product has been designed and manufactured to meet the highest standards of quality and durability. Subject to the «Warranty Terms» and «Warranty Limitations» sections below, it is warranted against defects in material or workmanship:

- **1 YEAR FOR THE WINDOWS**
- **2 YEARS FOR THE CANVAS**
- **5 YEARS FOR THE STRUCTURE**

In the event that the product is damaged or the warranty period has expired, please contact Gazebo Penguin's Customer Experience Department for a complete list of replacement parts and prices.

## WARRANTY LIMITATIONS AND EXCLUSIONS

1. This product is not warranted against damage caused by wind, falling objects, fire, animals, vegetation, vandalism and extreme weather conditions.
2. Collapsed shelter caused by snow, ice and wind accumulation
3. The roof must be kept free of snow and ice accumulation at all times.
4. Any damage that may be caused by snow and ice build-up will not be covered by the warranty. Snow and ice must be removed from the roof, from right to left, in five-foot (5) sections at a time.
5. Removal of snow and ice from the roof must be done from the outside of the car shelter. Doing so from the inside may damage the product and may cause serious injury to the person(s) involved in the removal.
6. It is strongly recommended that the product not be placed adjacent to buildings or trees as snow or ice may slide off the roof. In the event that the product is placed adjacent to a building or tree, additional precautions must be taken to ensure that there is no accumulation of snow or ice that could cause excessive weight to the product.
7. The product is warranted only if installed in accordance with Gazebo Penguin's written instructions included with the product.
8. The product is not warranted if it has been improperly anchored. In particular, the guide wires must be installed as shown. Anchors are not included for these guide wires and are dependent on the soil on which the shelter is installed.
9. In the event that the ground is not frozen when the product is installed, in addition to the floor hooks and nails, weights (not included) of at least 300 pounds for each 11' x 16' area must be installed.
10. Water infiltration through seams is not considered a manufacturing defect.
11. This product is not warranted against condensation, which may occur if the product is not installed on asphalt and the ground is not completely frozen at installation.
12. The cover/roof must be kept indoors if the outside temperature drops below +45°F/+7°C until it is placed on the frame. Otherwise, the windows may break and such breakage will not be covered by the warranty.
13. The covering material of this unit has been treated to resist damage from the sun's ultraviolet rays. However, it is mandatory that this product be disassembled and stored during the summer months in order to extend the life of this product.
14. The cover/roof must be clean and dry before storage. We strongly recommend that the original box in which the product was delivered be kept for off-season storage.
15. Discoloration and normal wear and tear of the cover/roof. The color of the material may naturally change over time.

## WARNING

Car shelter doors should be kept closed at all times, except when an engine is running, as there is a risk of asphyxiation.

---