



# MANUEL D'INSTRUCTIONS INSTRUCTION MANUAL

---

**Florence Solarium 10 Pl. X 12 Pl. - Toit d'Acier**  
**Florence Solarium 10 FT. X 12 FT. - Metal Roof**

---

sku: W1209MR-GP-12		
sku: W1209MR-GP-32		
sku: W1209MR-GP-42		

---

**NE DÉTRUISEZ PAS LES BOÎTES AVANT QUE L'ABRI SOIT COMPLÈTEMENT ASSEMBLÉ  
POUR LA RÉFÉRENCE FUTURE, PRENEZ DES PHOTOS DE TOUS LES SIX COTÉS DE CHACUNES  
DES BOITES À LA RÉCEPTION DU PRODUIT.**

**VEUILLEZ VÉRIFIER LE CONTENU DE CHAQUE BOÎTE A L'AIDE DE LA LISTE DES PIÈCES**

**10pi x 12pi / 3.04m x 3.65m Solarium  
LES INSTRUCTIONS D'INSTALLATION**

**IMPORTANT: RETENIR POUR LA FUTURE RÉFÉRENCE, LIRE ATTENTIVEMENT**

Consultez votre autorité locale / les codes municipaux locaux concernant l'installation de structures temporaires avant l'achat ou l'assemblage. Certaines juridictions peuvent exiger des permis pour, ou réglementer autrement, l'installation et l'utilisation.

Pour l'assistance de l'assemblage, d'installation, des pièces en particulier, ou service à la clientèle, veuillez contacter Gazebo Penguin au numéro de téléphone mentionné mi-bas : (français, anglais, lun. à ven. de 8 du matin à 4 après-midi est) :

**Montréal: (514) 276-3485**

**Canada et États-Unis: 1-800-737-7174**

**ATTENTION:**

- Pour une utilisation à l'extérieur.
- La neige doit être nettoyée en tout temps, ne pas laisser s'accumuler.
- Conserver votre **preuve d'achat** pour la garantie. Veuillez **garder les boîtes** jusqu'à la fin de l'installation.
- D'assemblage peut durer plus que 4 heures et l'exige d'avoir au moins 3 personnes.



**AVANT ASSEMBLAGE:**

- Veuillez ne pas détruire les boîtes avant d'avoir terminé l'assemblage.
- La fondation doit être sous le niveau de sol, plat et solide, comme du béton ou de l'asphalte.
- Tenez à l'écart des lignes électriques aériennes, des branches d'arbres et d'autres structures.
- Vérifiez s'il y a des tuyaux ou des fils souterrains si le creusement ou le forage est nécessaire.
- Ne pas installer à proximité des lignes de toit ou d'autres structures qui pourraient jeter de la neige, de la glace ou une pluie excessive sur le toit.
- Assemblez la structure près du point final d'utilisation la plus proche possible.
- Il est recommandé de porter des gants de sécurité, des lunettes de sécurité et des casques de protection pour l'installation.
- Ne vous suspendez pas, ne grimpez pas et ne vous tenez pas debout sur la structure ou le toit.
- Avant le montage, lisez les instructions et vérifiez que toutes les pièces sont présentes dans les boîtes. S'il manque des pièces, svp, contactez notre département de garantie.
- Un escabeau de 6 pieds (1,8 m), un tournevis Phillips, un ruban à mesurer, un niveau, un maillet et une bâche sur laquelle placer les pièces seront nécessaires pour l'assemblage (non inclus).
- Enlevez le film protecteur supérieur des panneaux de toit avant l'assemblage; **NE PAS** retirer le film protecteur inférieur avant d'être prêt à insérer les panneaux de toit, afin d'identifier le côté supérieur.

**INSTRUCTION D'ANCRAGE:**

- Un ancrage adéquat du cadre à la base et au mur est nécessaire pour la sécurité.
- Une structure non solidement ancrée a un risque de s'envoler lors de vents violents causant des dommages et des risques pour la sécurité.
- Le matériel et les outils requis pour l'ancrage varient en fonction de l'emplacement d'installation et ne sont pas fournis.
- Veuillez vérifier auprès de votre quincaillerie locale les ancrages appropriés à votre surface.

**SOIN ET MAINTENANCE:**

- En cas de pièce défectueuse ou endommagée, ou pour toute autre question concernant le produit, veuillez contacter directement le fabricant.
- Veuillez avoir la liste des pièces et les numéros de pièces à portée de main lors de la commande ou de la demande de pièces de rechange.

**PANNEAUX DE TOIT:**

- Nettoyez doucement avec une solution savonneuse écologique et de l'eau à l'aide d'une éponge.
- N'utilisez pas de matériaux abrasifs, de brosses métalliques, de produits chimiques, de nettoyeurs puissants ou d'eau de javel.
- Rincer à l'aide d'un tuyau d'arrosage et sécher à l'air. S'il est retiré, assurez-vous qu'il est complètement sec avant le stockage.
- N'utilisez pas de nettoyeur haute pression.

**STRUCTURE:**

- Nettoyez doucement avec une solution savonneuse écologique et de l'eau à l'aide d'une éponge.
- N'utilisez pas de matériaux abrasifs, de brosses métalliques, de produits chimiques, de nettoyeurs puissants ou d'eau de javel.
- Rincer à l'aide d'un tuyau d'arrosage et sécher à l'air. N'utilisez pas de nettoyeur haute pression.
- S'il y a des imperfections voir le numéro de pièce de la peinture dans la liste des pièces pour obtenir une peinture de retouche correspondante.

**LES DIMENSIONS SONT APPROXIMATIVES.**



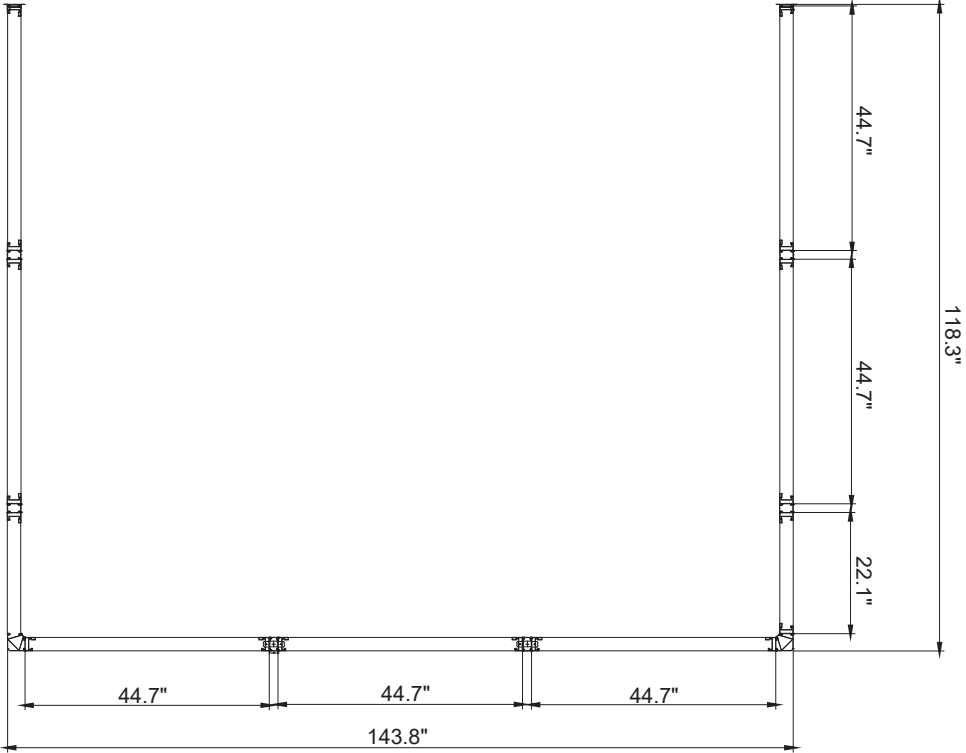



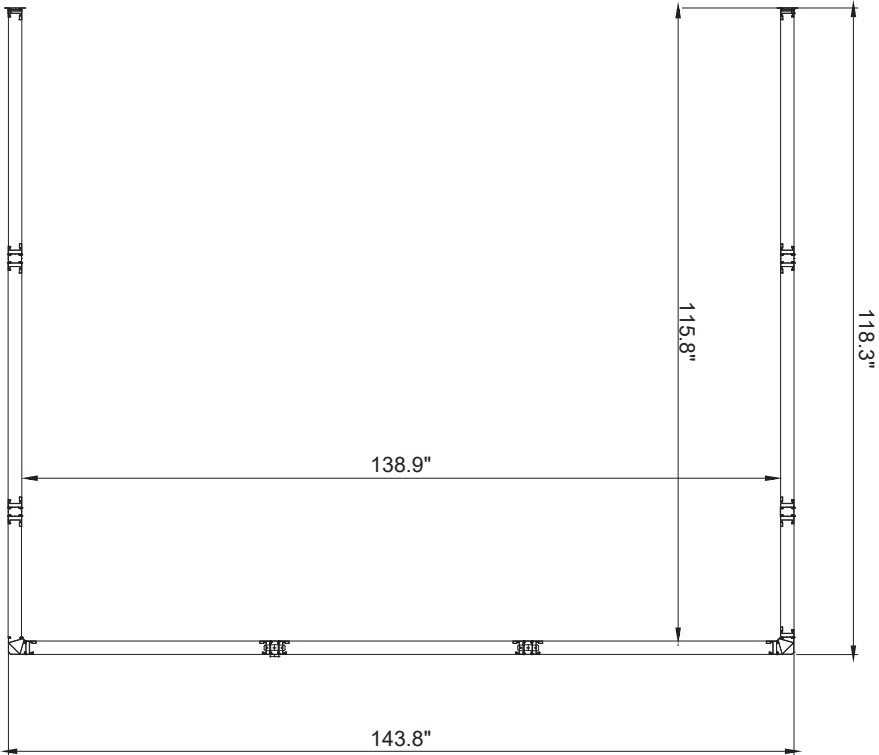



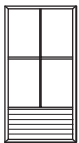

10X12 ADD A ROOM  
 PANNEAUX A LA BASE  
 PANELS AT BASE

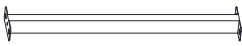

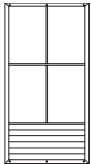



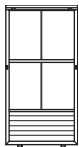
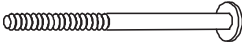
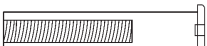
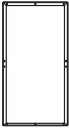
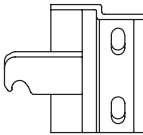
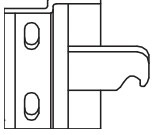

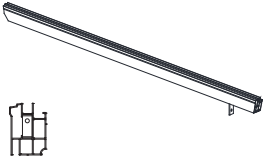
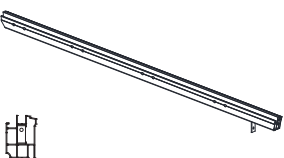

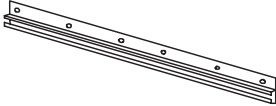
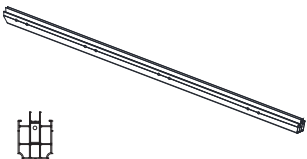
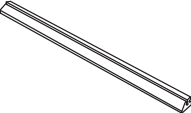





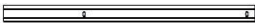

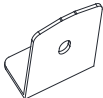



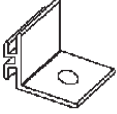





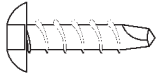

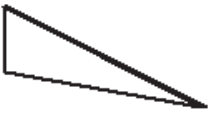
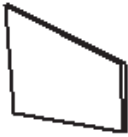

10X12 ADD A ROOM  
 AU REBORD DU TOIT  
 ROOF OVERHANG



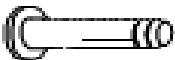

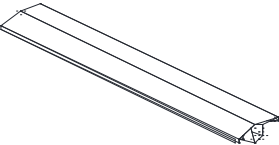
## 10 x 12 solarium

DESCRIPTION	EMBALLE DANS LA BOITE	QTÉ	DESSIN	DESCRIPTION	EMBALLE DANS LA BOITE	QTÉ	DESSIN
23-316 Panneau de toit (47.2"x44.5") A	1	4		23-317 Panneau de toit (45.6" x 44.5") A1	1	2	
23-093 Cadre Régulier A-3	2	2		23-318 Demi Cadre A-3 1/2	2	1	
	3	1			3	1	
23-239 Tube de Support Latéral (46") LI-3	4	8		23-243 Tube de support central (44.4") Jj-3	4	4	
23-094 Cadre Adjacent B-3 (Trous Supplémentaires)	2	1		25-114 Boulon Bb-3	4	76	 (M6*16mm)
	3	1					
23-319 Panneau de toit (47.2" x 41.8") C	1	2		23-320 Panneau de toit (45.6" x 41.8") C1	1	1	
23-095 Porte Coulissante C-3	2	1		20-115 Boulon Cc-3	4	20	 (M6*73mm)
	3	1					
25-117 Boulon Femelle Cc-3-2	4	12	 M5*60mm	10-499 Cadre pour porte Coulissante D-3	2	1	
					3	1	
08-169 Loquet de porte gauche Dd-L-3	4	2		08-165 Loquet de porte droit Dd-R-3	4	2	
11-544 Pecce de connection E-3	4	12		08-138 Butoir en Plastique H-3	4	4	
23-321 Chevron latéral gauche (124.1") F	4	1		23-322 Chevron latéral Droit (124.1") F1	4	1	

DESCRIPTION	EMBALLÉ DANS LA BOITE	QTÉ	DESSIN	DESCRIPTION	EMBALLÉ DANS LA BOITE	QTÉ	DESSIN
23-241 Rail de porte Supérieur (90.4") F-3	4	2		23-323 Chevron Régulier (124.1") G	4	2	
11-546 Rail de porte inferieur (88.5") G-3	4	2		08-187 Rondelle Gg-3	4	96	
10-500 Récepteur Latéral Gauche I-3	4	1		12-161 NUT Hh-3-2	4	4	
10-501 Récepteur Latéral Droit J-3	4	1		10-502 Connecteur d'angle K-3	4	2	
23-324 Traverse Gauche (59.8") L-1	4	1		23-325 Traverse Droit (83") L-2	4	1	
23-246 Joint de poutre supérieur M	4	4		23-314 Rail Mural (72.5") ML-3	4	1	
23-315 Rail Mural (72.5") MR-3	4	1		10-505 Joint de rail N-3	4	1	
08-134 Embout Supérieur du rail arrière Nn	4	4		10-506 Support de Chevron O-3	4	2	
08-135 Vis Oo-3	4	4	 (M4*12mm)	10-507 Joint de pignon gauche P-3	4	1	
25-203 Paravent Latéral (45.9") Zz-3	4	2		25-204 Paravent Central (44.3") Yy-3	4	1	

DESCRIPTION	EMBALLE DANS LA BOITE	QTÉ	DESSIN	DESCRIPTION	EMBALLE DANS LA BOITE	QTÉ	DESSIN
13-045 Vis Auto perçante PQ-3	4	2		10-508 Joint de pignon droit Q-3	4	1	
25-205 Panneau de pignon arrière gauche Rr-3	2	1		25-206 Panneau de pignon avant gauche Ss-3	2	1	
25-207 Panneau de pignon arrière droit Tt-3	2	1		15-125 Support pour chevron régulier U-3	4	2	
25-208 Panneau de pignon avant droit Uu-3	2	1		23-256 Guide Mural Gauche (94.3") Vv-3	4	1	
25-118 Boulon Ww	4	12	 M5*15mm	23-257 Guide Mural Droit (94.3") Ww-3	4	1	
10-529 Vis d'ancrage mural Xx-3	4	18		08-156 Vis Z-3	4	4	 M4*16mm
23-326 Barre de toit flexible (124") V-3	4	4		23-258 Gouttière Centrale (48") Y-3	4	1	
23-259 Gouttière latérale (49.5") X-3	4	2		21-040 Boulon Vv-1	4	16	 M6*65mm
23-007 PLASTIC PLUG Kk	4	4					

DESCRIPTION	EMBALLE DANS LA BOITE	QTÉ	DESSIN	DESCRIPTION	EMBALLE DANS LA BOITE	QTÉ	DESSIN
23-215 Clé Hexagonale QQ	4	1	 4#	25-198 Lame à Ressort PP	4	40	
23-223 Clé Hexagonale RR	4	1	 3#				

ENLEVEZ L'AUTOCOLLANT AVANT L'ASSEMBLAGE

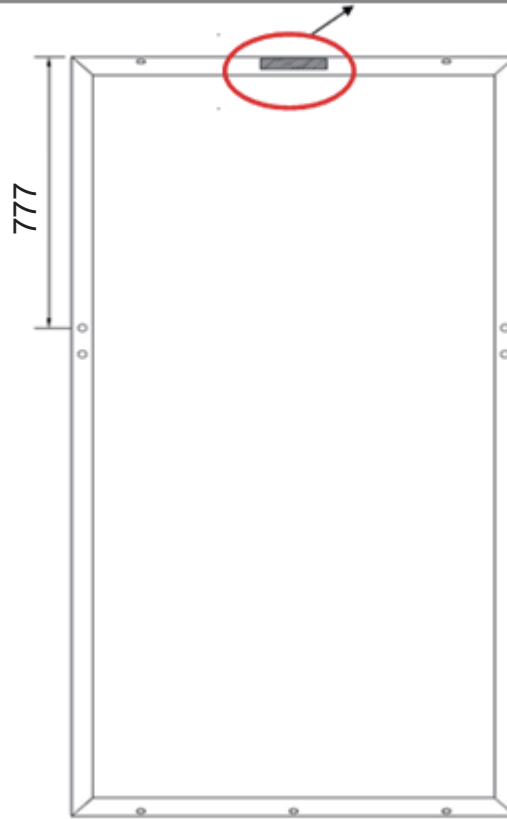
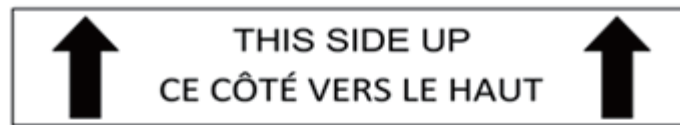

D-3 FRAME

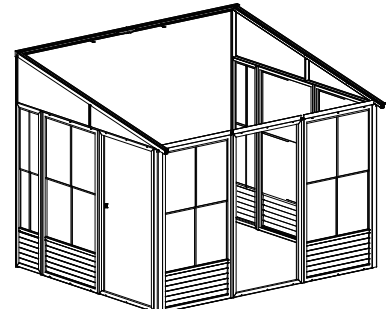
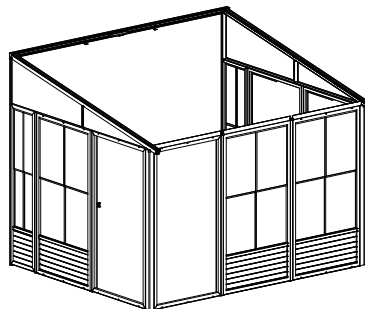
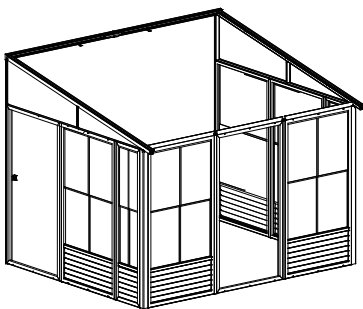

**Voici quelques possibilités**

**La porte coulissante peut être placée n'importe où, à condition que le cadre adjacent de la porte soit à côté de la porte.**

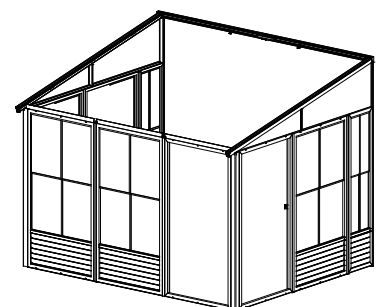
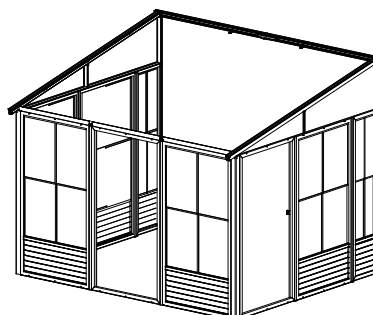
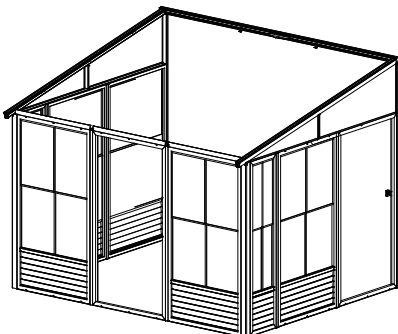

## **OUTILS NÉCESSAIRES:**

- Tournevis (Philips #2)
- Couteau
- Lime lisse
- Pince à bec effilé
- Maillet en caoutchouc
- Escabeau (hauteur minimale de 6 pieds)
- Spatule
- Perceuse électrique
- Tube de silicone
- Foret 5/16" ciment (selon la surface)
- Lime ronde et plate
- Planche de bois 2" x 4" x 8"

## **Avant de commencer:**

Assurez-vous que vous disposez d'une base solide, telle une terrasse en ciment ou en bois, dont l'inclinaison ne dépasse pas 1" x 8".

Évitez d'installer le solarium près d'un arbre ou un toit en pente car la neige et la glace pourraient glisser et provoquer l'effondrement de celui-ci.

NE DETRUISEZ PAS les boîtes avant que le solarium soit totalement assemblé.

## **Sens de placement de la porte :**

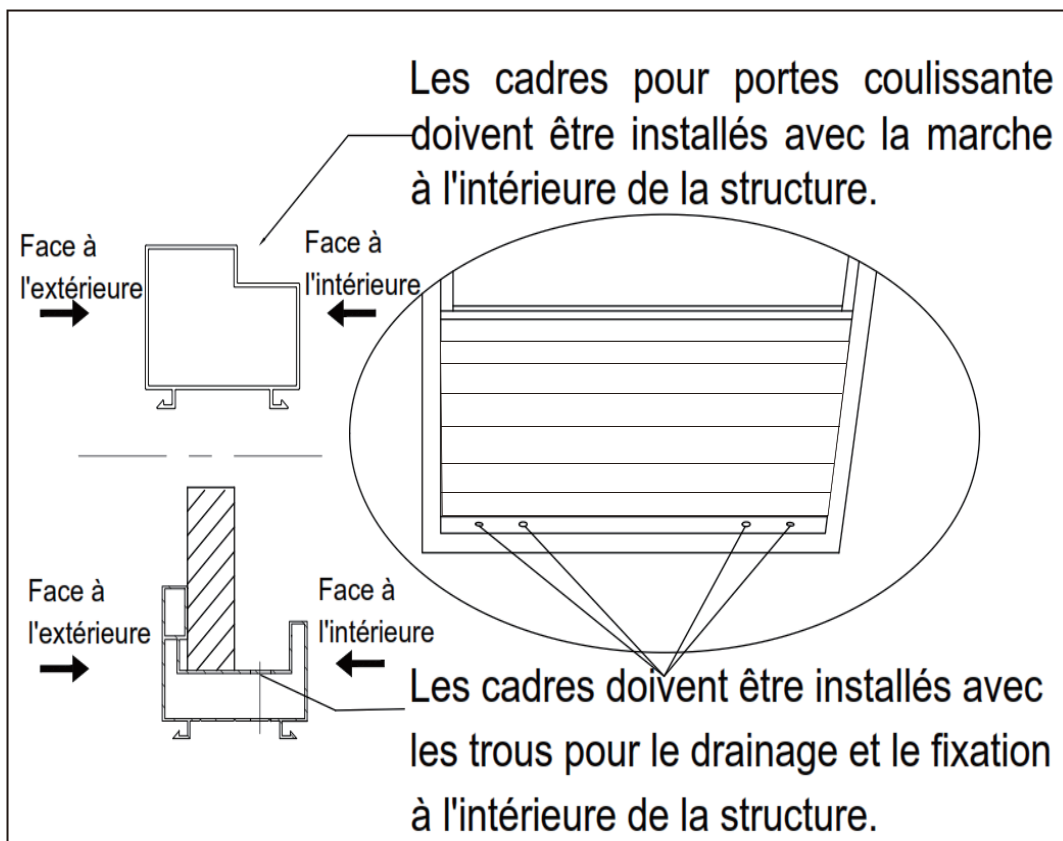

## Étape 1

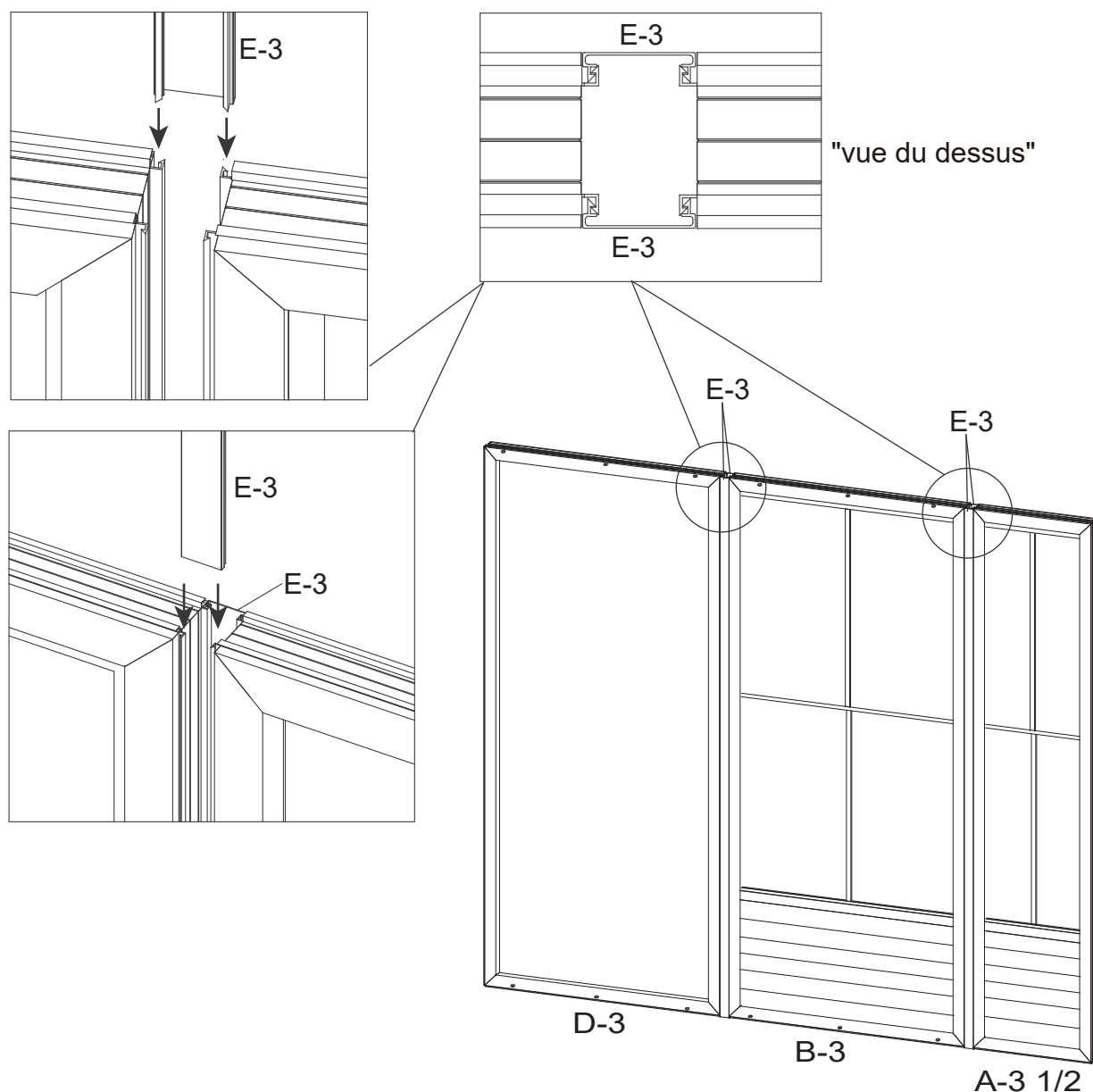

1.1. Avant assembler votre solarium, déterminez la position des cadres de porte en fonction de l'endroit où vous souhaitez glisser la porte. À l'avant du solarium, utilisez le cadre de porte coulissante (D-3) pour l'ouverture de la porte et utilisez le cadre adjacent (B-3) pour la direction de la porte lorsqu'elle sera ouverte.

1.2. Alignez le cadre de la porte coulissante (D-3) avec le cadre adjacent (B-3) en utilisant la pièce de connexion (E-3). Insérez le cadre de la porte coulissante (D-3) à l'intérieur de cadre adjacent (B-3). Répétez l'opération pour l'extérieur. Ensuite, alignez le cadre adjacent (B-3) avec le demi-cadre (A-3 1/2), utilisez la pièce de connexion (E-3) pour insérer le cadre adjacent (B-3) et à l'intérieur du demi-cadre (A-3 1/2).

### NOTE:

Lorsque vous faites glisser les connecteurs (E-3), secouez les cadres pour qu'ils glissent facilement. N'utilisez pas d'outils pour forcer. Si nécessaire, nettoyez la peinture avec une lime et assurez-vous que les extrémités des cadres et des joints ne soient pas pliées ou déformées. Dans l'éventualité, utilisez la pince à bec effilé pour redresser.

## Étape 2

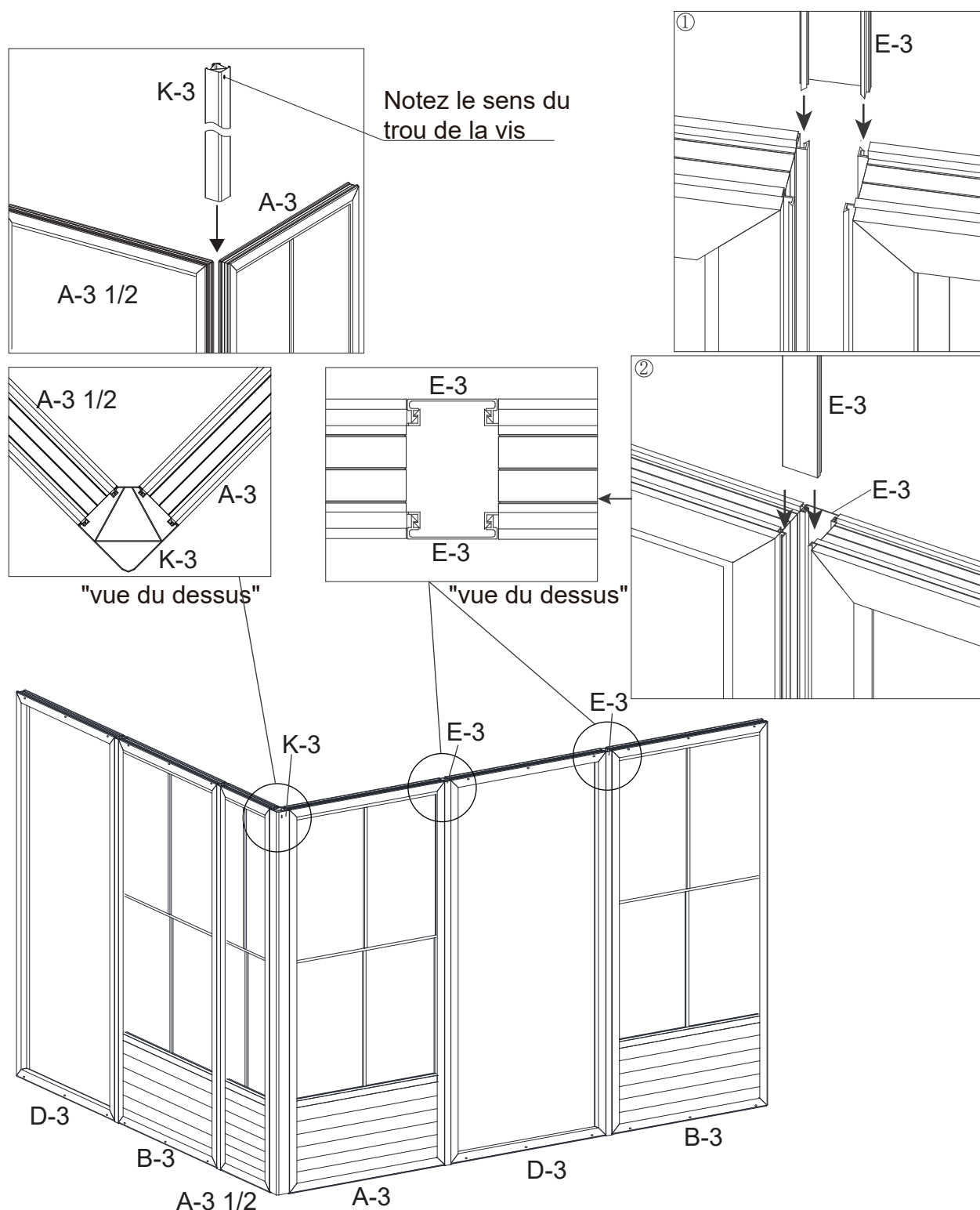

2. Connectez le cadre régulier (A-3), le cadre de la porte coulissante (D-3) et le cadre adjacent (B-3) avec le connecteur d'angle (K-3) et la pièce de connexion (E-3) ensemble. Assurez-vous que les têtes des boulons soient orientés vers le haut et vers l'extérieur. (Référez-vous au croquis à la page 8.)

NOTE: Lorsque vous placerez l'ouverture du cadre de porte régulier (A-3) se trouvent à l'intérieur et sur la moitié supérieure du cadre du solarium. La porte sera placée à l'intérieur en raison de l'espace libre.

### Étape 3

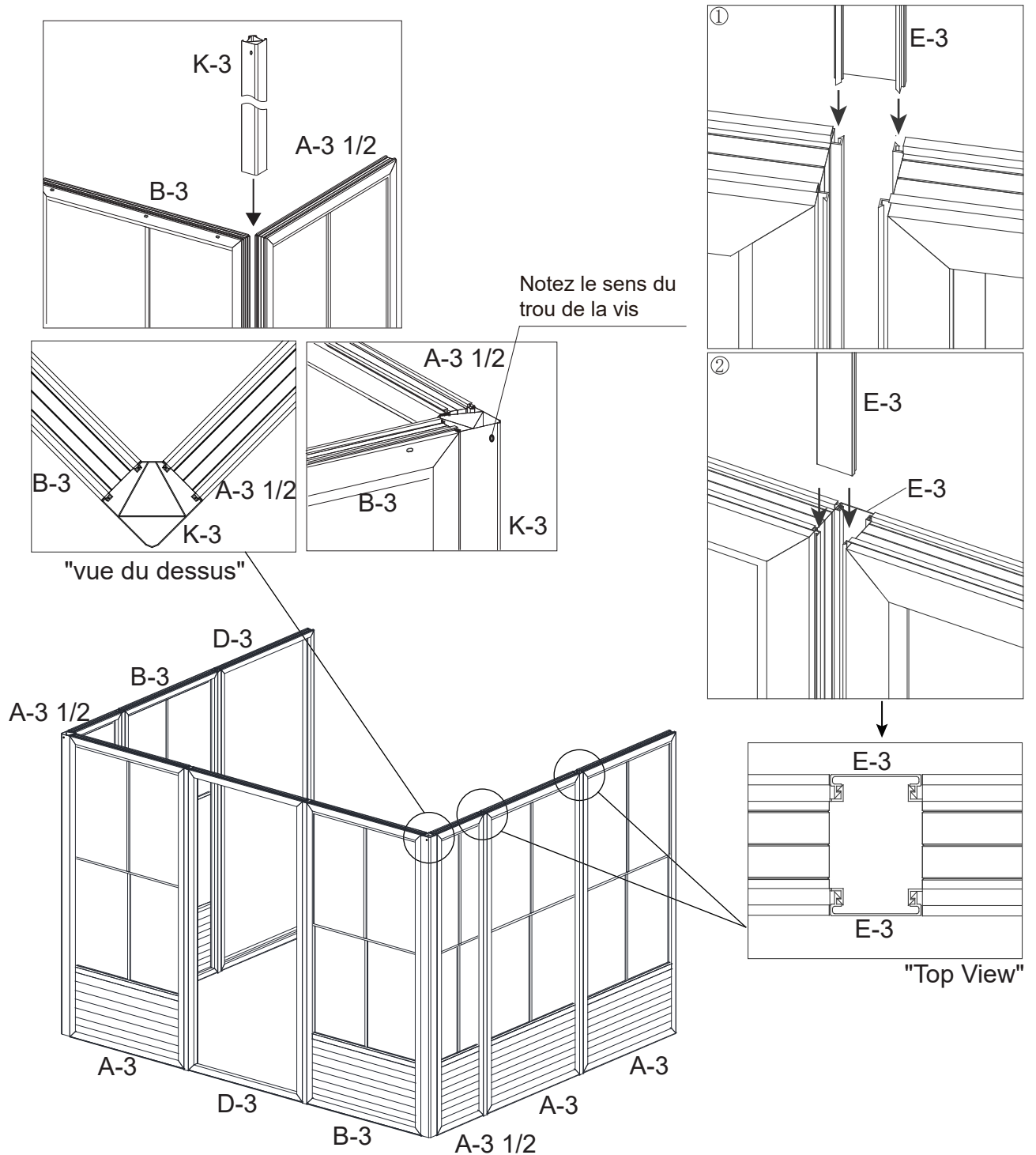

3. Reliez le reste du cadre régulier (A-3) et le demi-cadre (a-3 1/2) avec le connecteur d'angle (K-3) ainsi qu'avec la pièce de connexion (E-3), le connecteur d'angle (K-3). Assurez-vous que les trous des boulons soient orientés vers le haut et vers l'extérieur. (Référez-vous au croquis à la page 8.)

## Étape 4

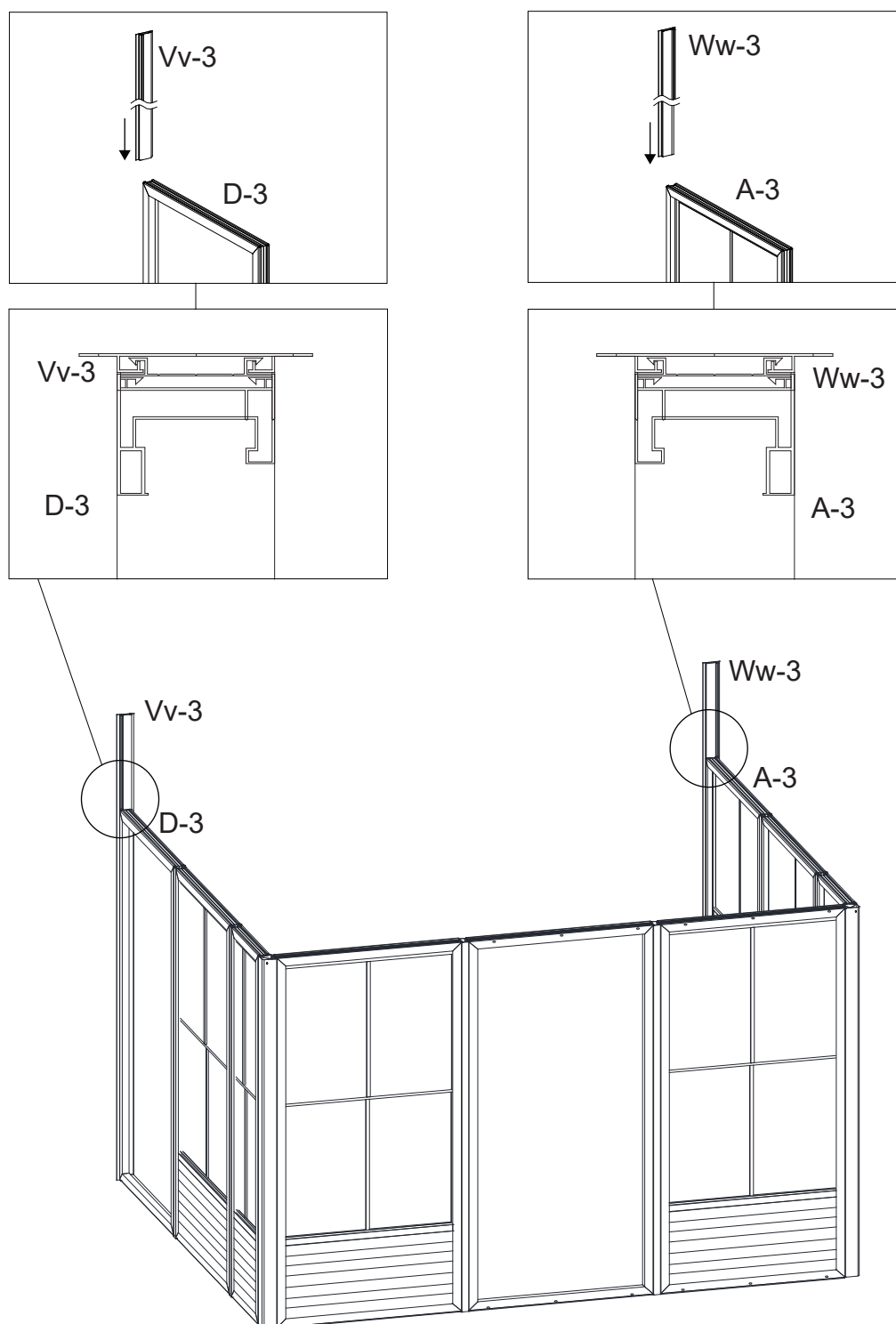

4. Faites glisser le guide mural gauche (Vv-3) ainsi que le guide mural droit (Ww-3) dans les 2 extrémités des cadres (A3/D3), le long des rainures, en secouant pour faciliter le mouvement.  
Note: Les rainures doivent rester à l'extérieur sur les guides (Vv-3) et (Ww-3).

## Étape 5

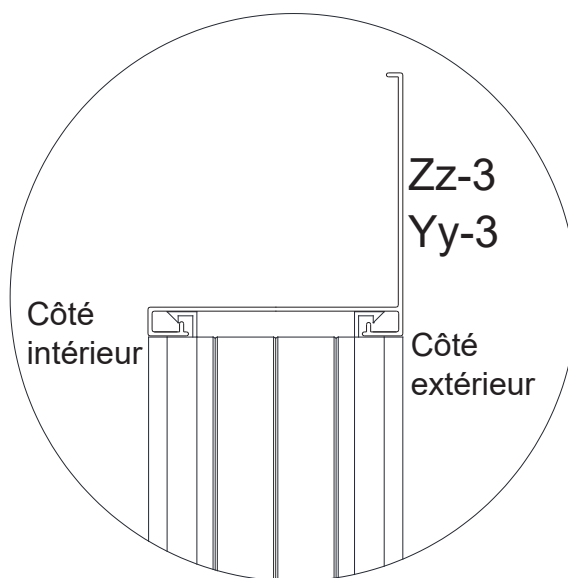
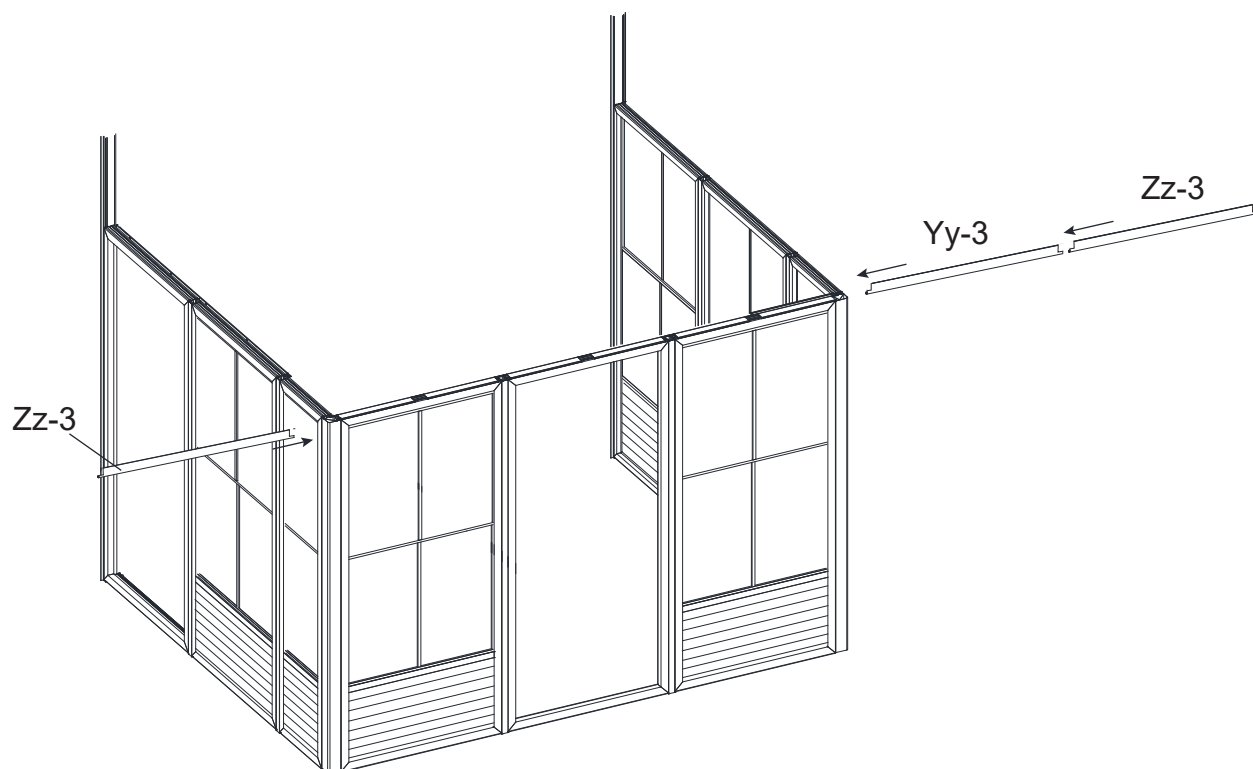

5. Insérez les deux paravents latéraux (Zz-3) aux paravents centraux (Yy-3) dans la porte le long du rail.  
NOTE: Attention à la direction des paravents (Voir le croquis à la page 5).

## Étape 6

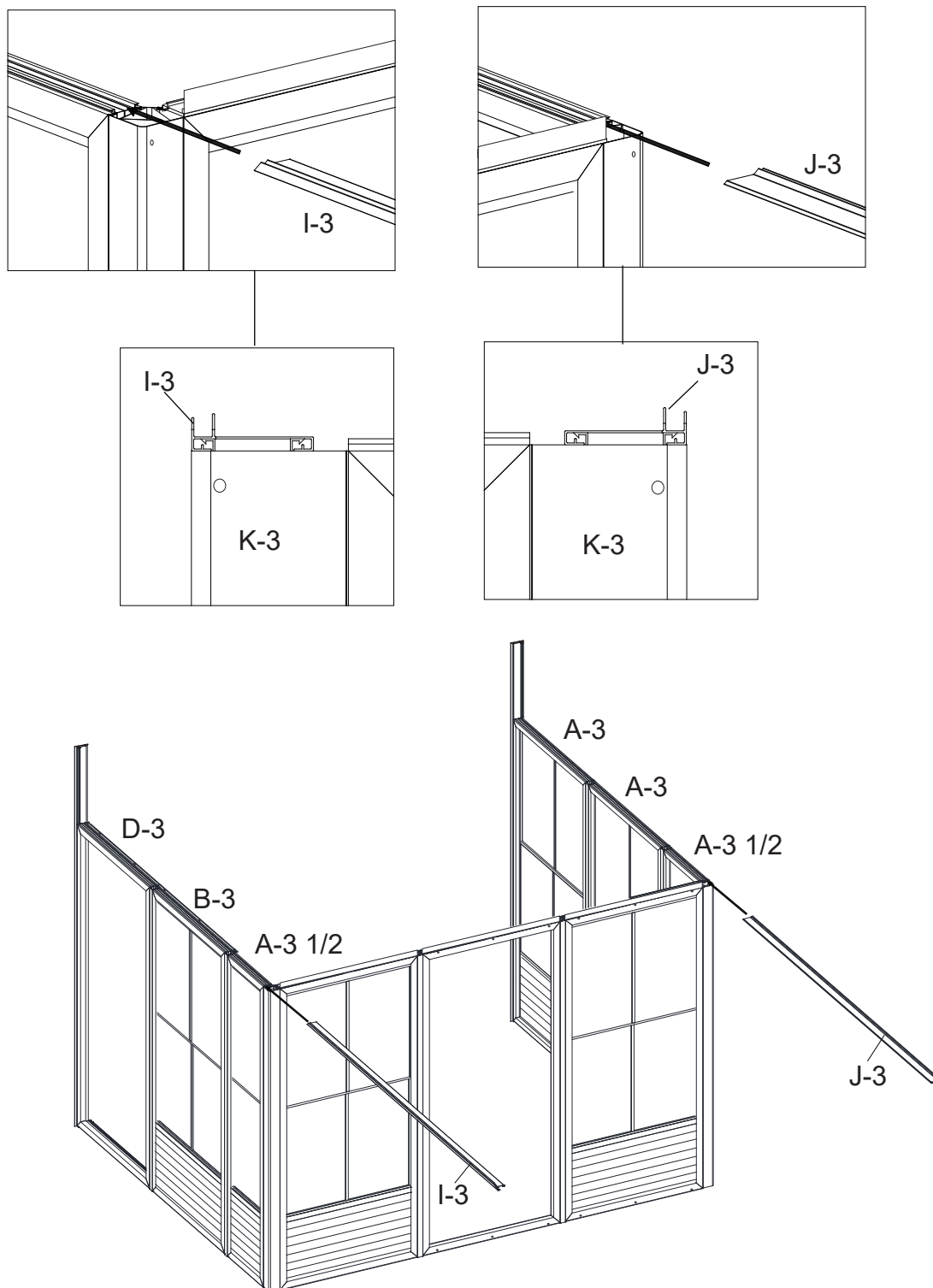

6. Insérez le récepteur latéral gauche (I-3) et le récepteur latéral droit (J-3) en haut du cadre. Assurez-vous que les deux cadres sont au bon niveau, sinon utilisez des cales pour compenser. Ne pas utiliser d'outils pour forcer.

## Étape 7

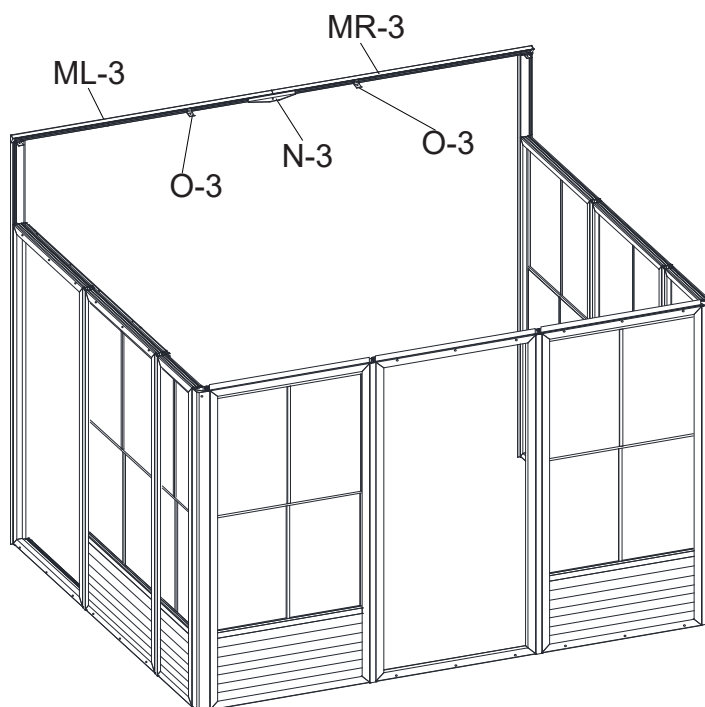
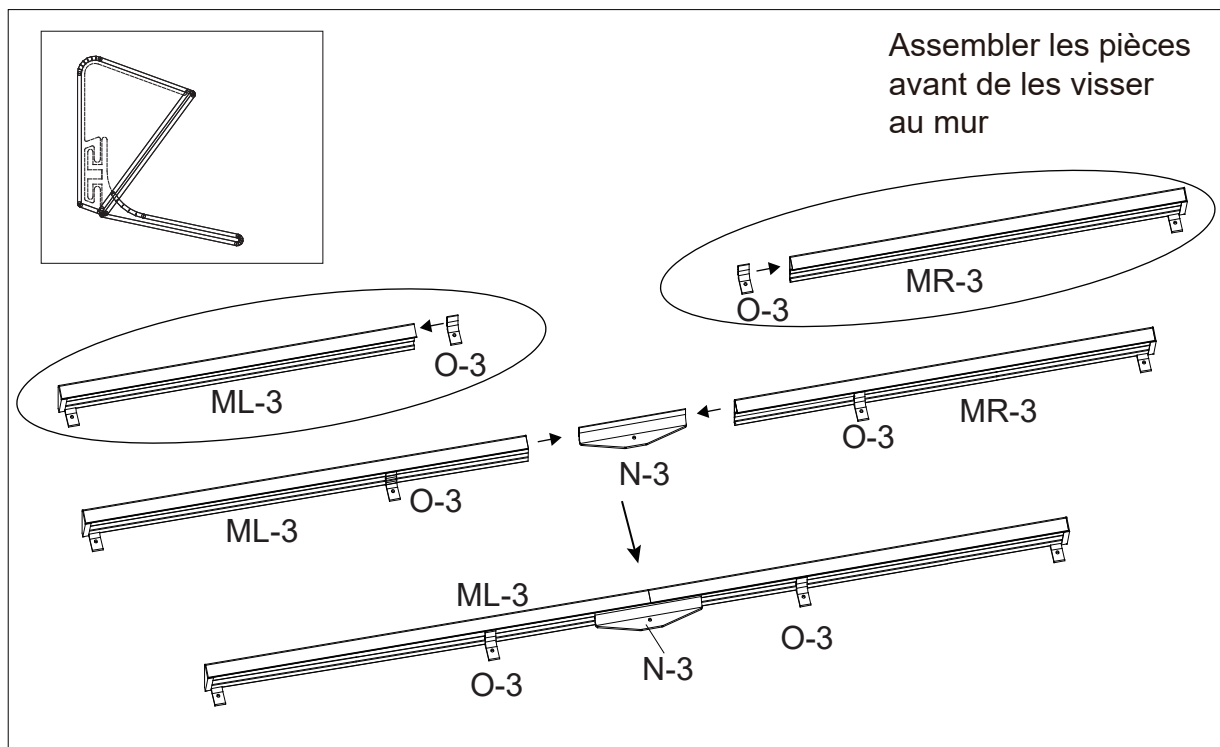

7.1 Assemblez les rails muraux (ML-3/MR-3), les joints de rail (N-3), le support de chevron (O-3) comme indiqué et positionnez-les uniformément au-dessus des guides verticaux, à 97" du sol. Fixez les rails muraux et les rails verticaux au mur en briques ou au ciment en perçant l'aluminium, à intervalles de 16" (minimum) en utilisant les vis (Xx-3).

### Remarque :

Une fois le rail mural en place, appliquez du silicone le long de la partie supérieure et à la jonction des 2 rails verticaux.

## Étape 8

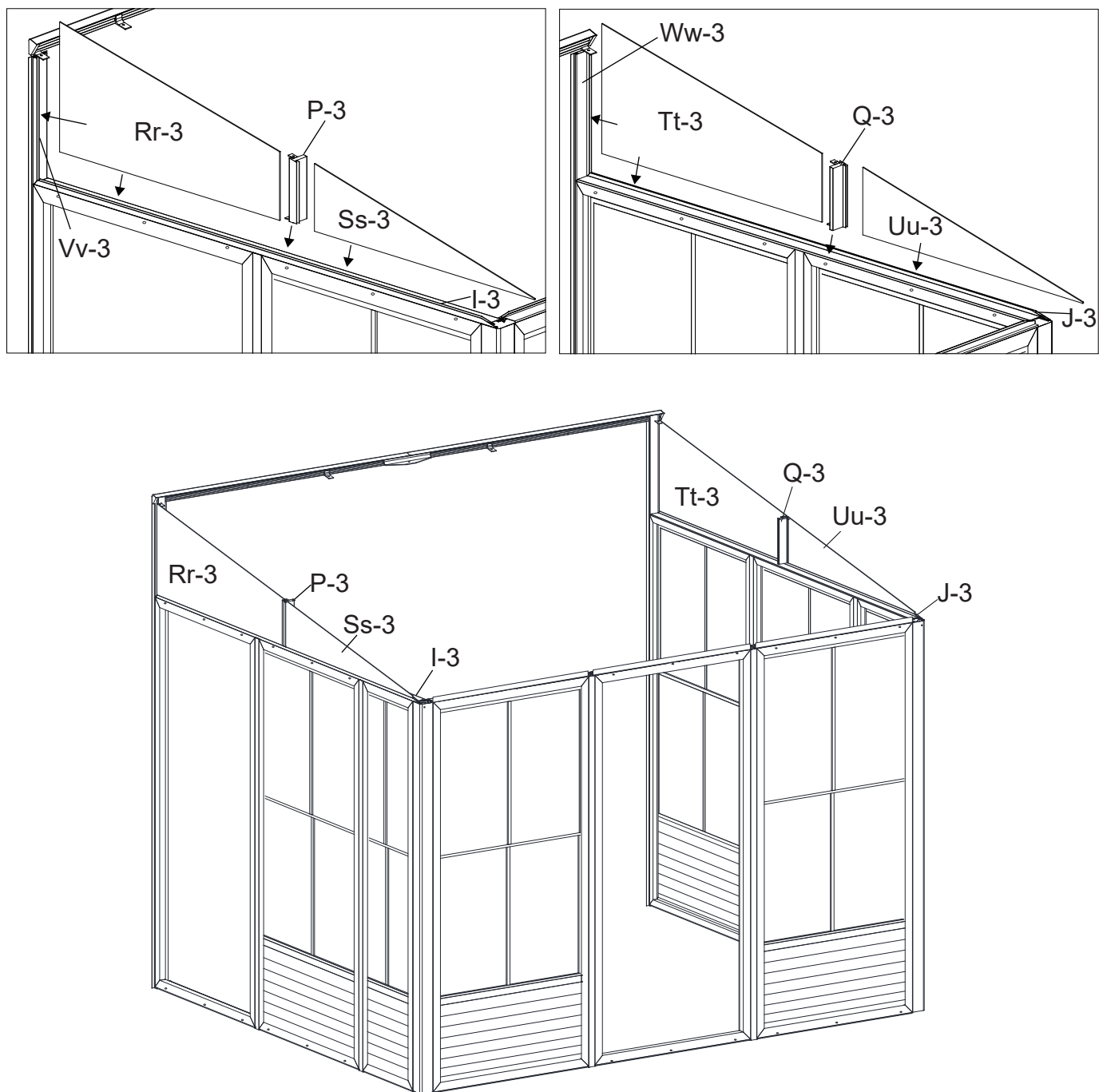

8. Placer la face exposée du polycarbonate à l'extérieur, sur le récepteur latéral gauche (I-3). Utilisez le panneau de pignon arrière gauche (Rr-3), un joint de pignon gauche (P-3) et un panneau de pignon avant gauche (Ss-3). Faites le côté droit avec le panneau de pignon arrière droit (Tt-3), un joint de pignon droit (Q-3) et le panneau de pignon avant droit (Uu-3) sur le panneau du récepteur latéral droit (J-3).

## Étape 9

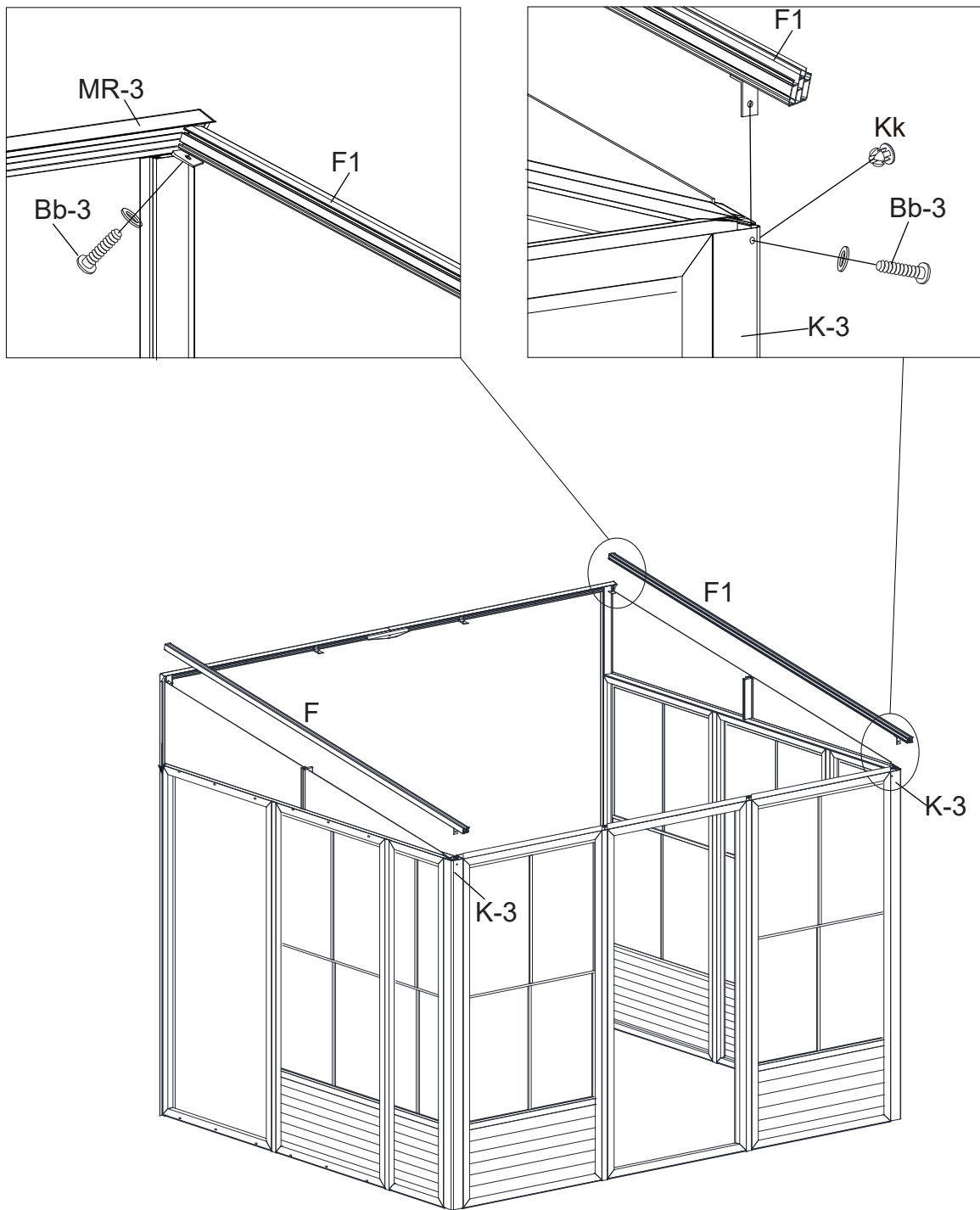

9. Placez le chevron latéral droit (F1) sur le dernier support, puis fixez-le au connecteur d'angle (K3) au joint de pignon droit (Q-3) à l'aide des vis (Bb-3). Répétez la même étape pour le côté gauche avec le chevron latéral gauche (F) et au joint de pignon (P-3) et les vis (Bb-3).

## Étape 10

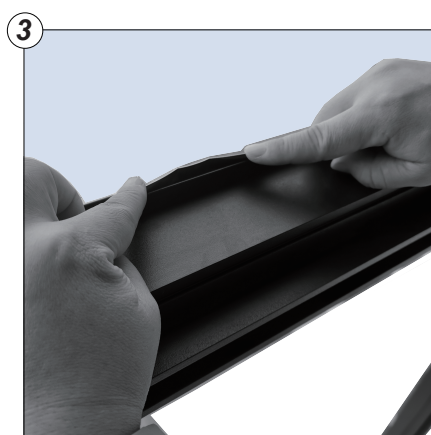
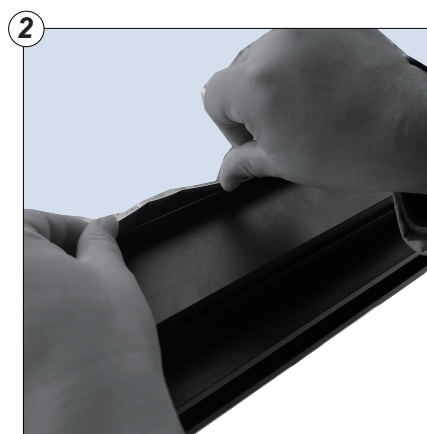
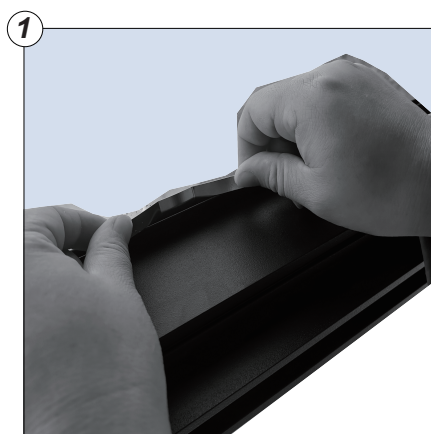
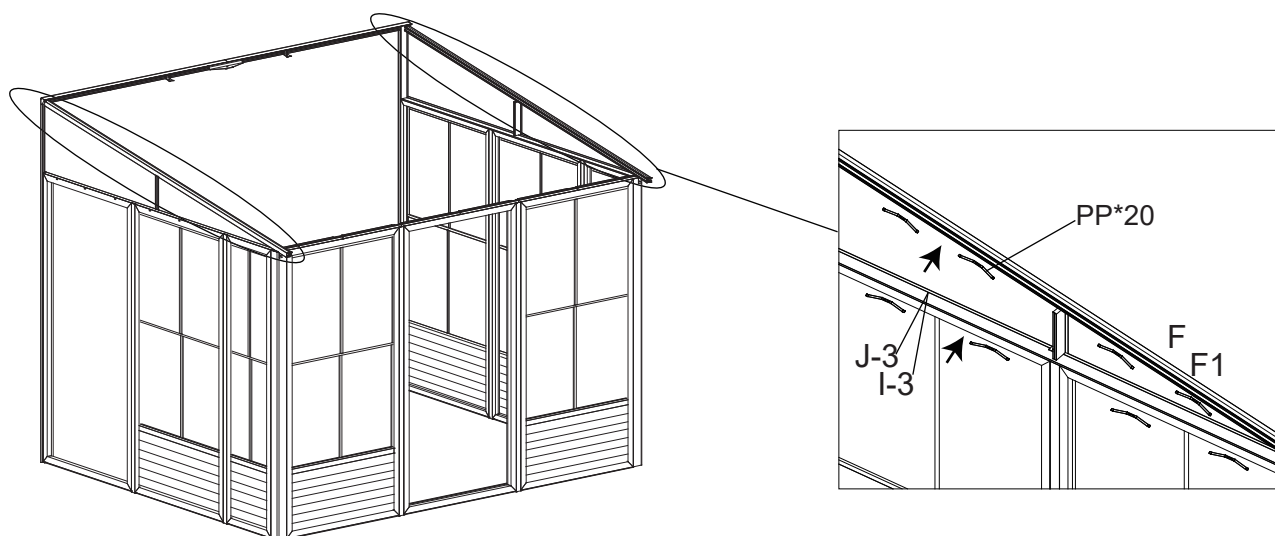

10. Installer la lame à ressort (PP) dans la rainure intérieure des Chevrons (F/F1) et du récepteur latéral (I-3/J-3). Elle sert à maintenir le panneau en place.

## Étape 11

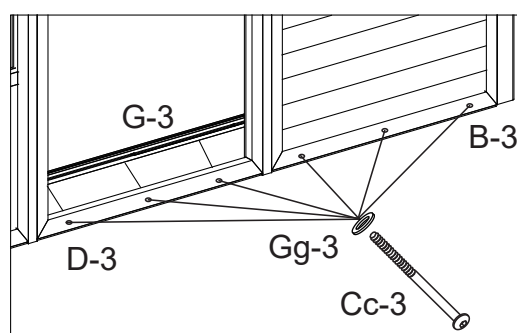
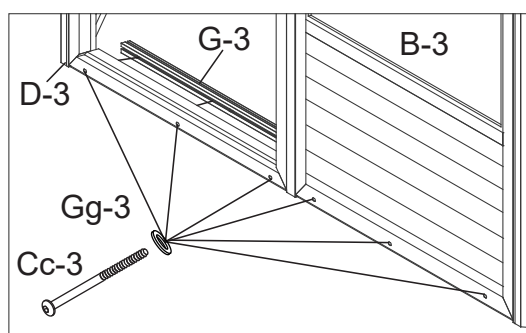
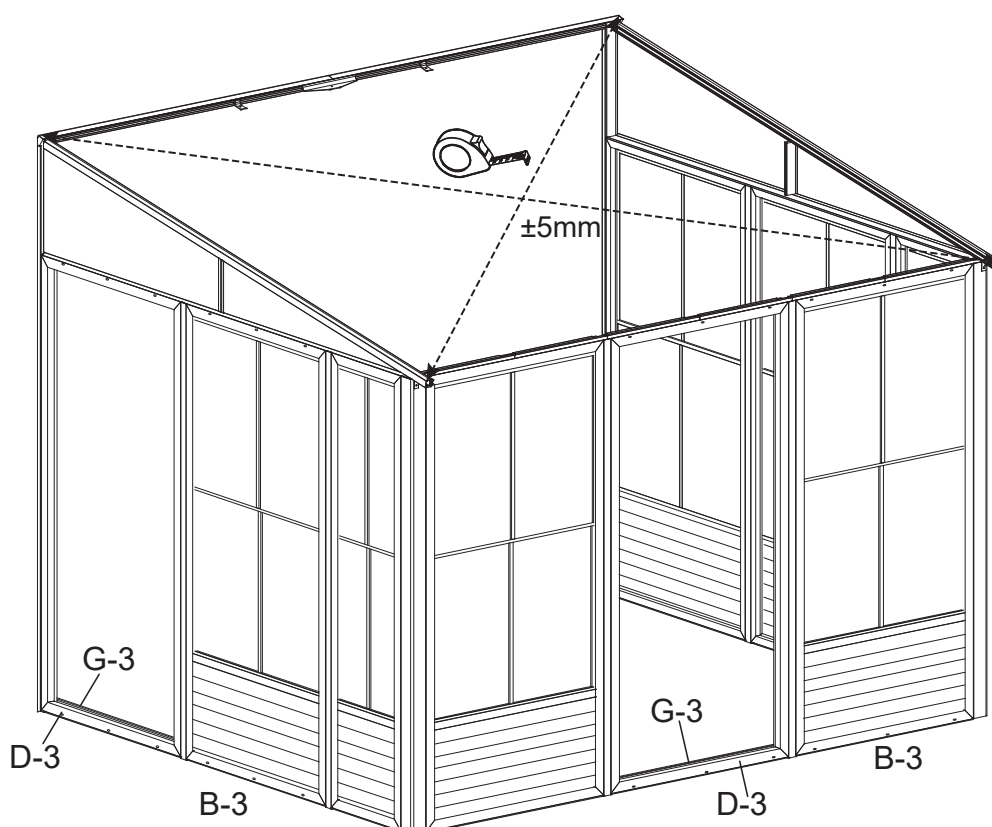

11. Fixez le cadre de la porte coulissante (D-3), le cadre de porte adjacent (B-3) et le rail de la porte inférieure (G3) en utilisant les boulons (Cc-3) et les rondelles (Gg-3).

### REMARQUE :

Assurez-vous que les mesures en diagonales de l'ensemble du cadre se trouvent à la même distance de 5 mm près.

## Étape 12

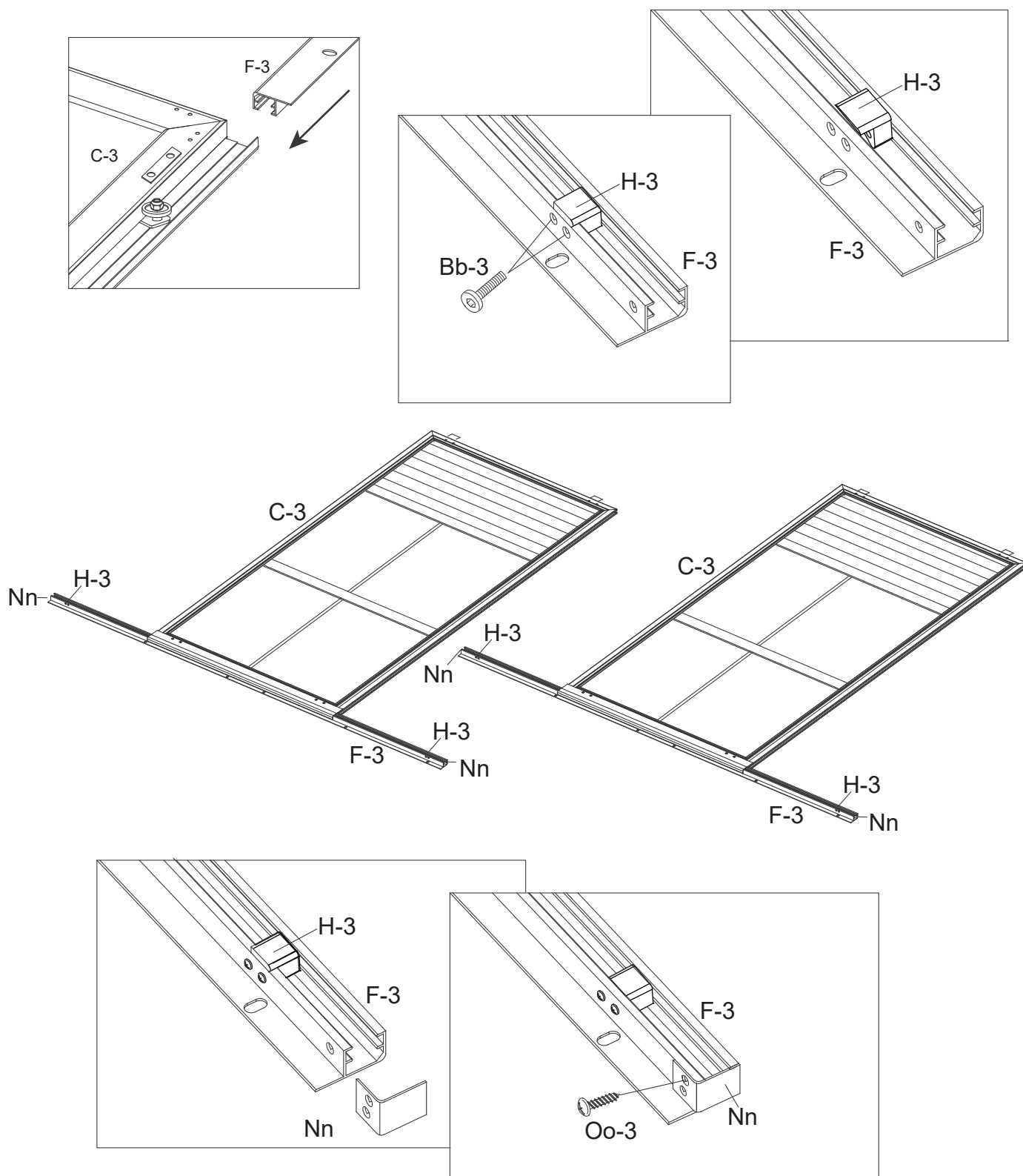

12.1 Insérez le rail de de la porte supérieure (F-3) dans la pièce de connexion située en haut de la porte coulissante (C-3).

12.2 Fixez le bouchon en plastique (H-3) aux deux extrémités du rail de la porte supérieure (F3) à l'aide des boulons (Bb-3).

12.3 Fixez l'embout supérieur du rail de porte (Nn) aux deux extrémités du rail supérieur de la porte (F-3) à l'aide des boulons (Oo-3).

## Étape 13

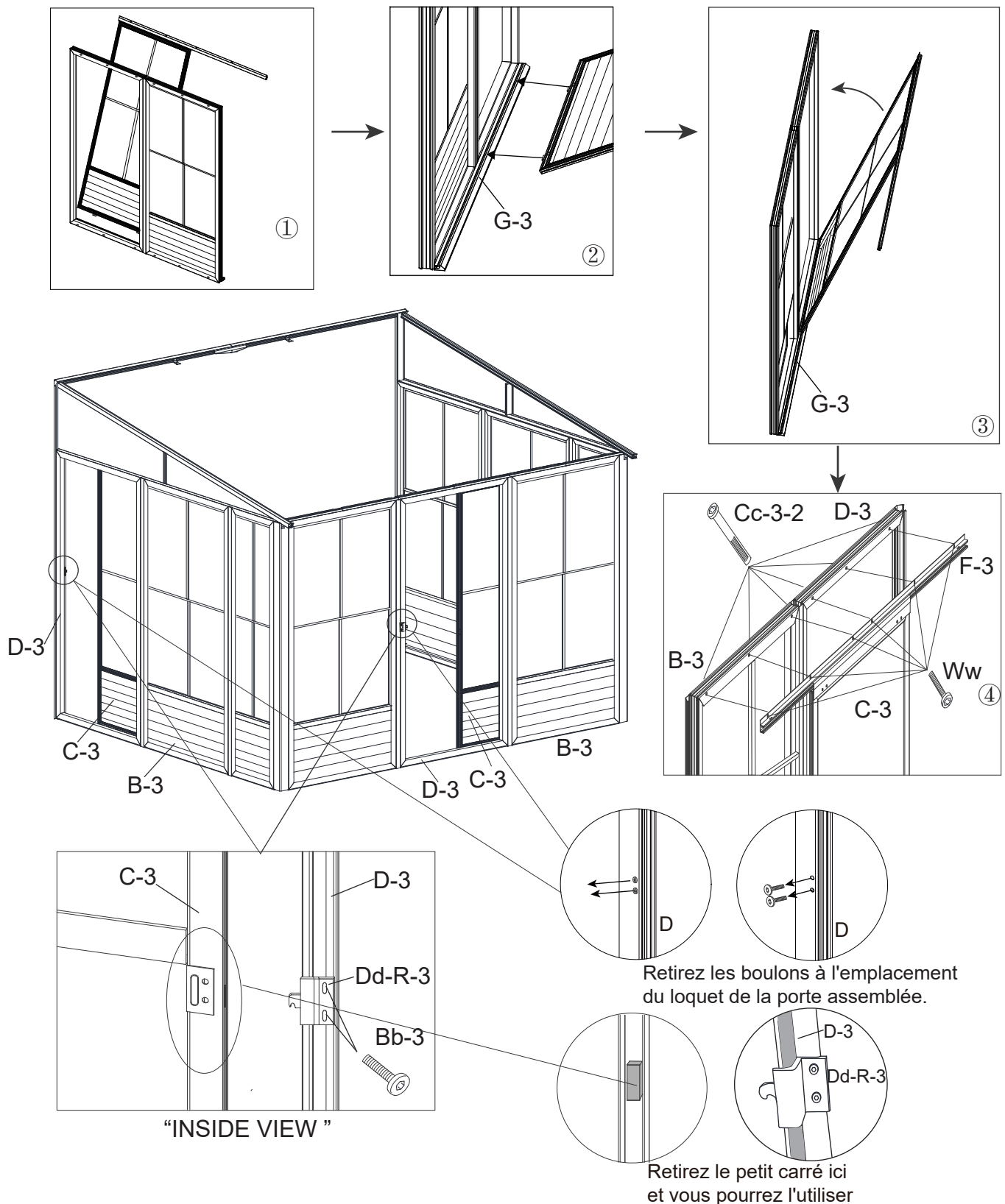

13.1 Installez la porte coulissante assemblée (C-3) à la verticale, insérez l'extrémité inférieure dans le rail inférieur de la porte (G-3) à l'aide des boulons (Cc-3-2/Ww). Veillez à pousser vers le haut le rail supérieur de la porte (F-3) afin que les portes ne frottent pas sur les rails.

13.2 Fixez le loquet de la porte droite (Dd-R-3) au cadre de la porte coulissante (C-3) à l'aide des boulons (Bb-3).

## Étape 14

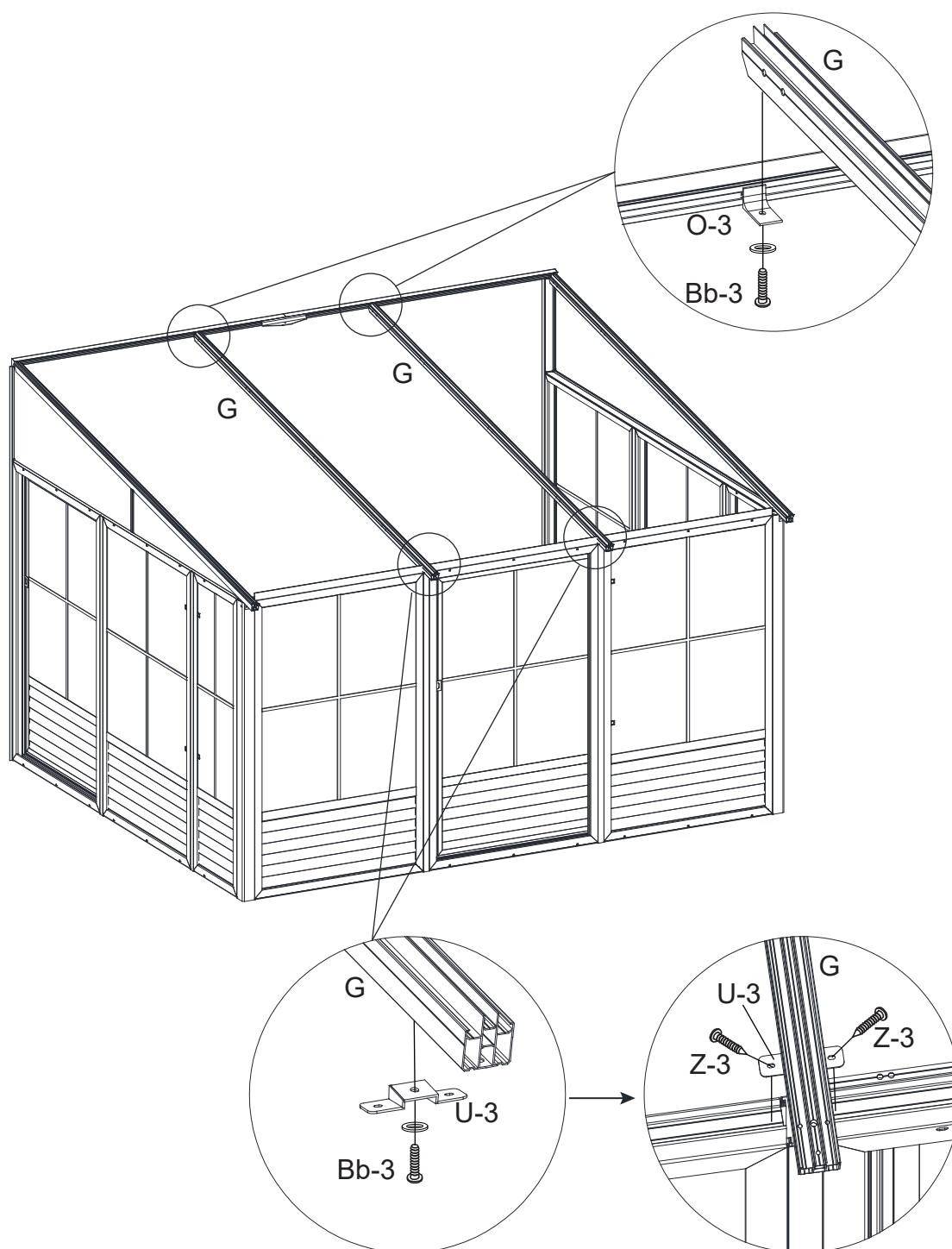

14. Fixez le support de chevron régulier (U-3) et le chevron régulier (G) ensemble à l'aide des boulons (Bb-3). L'extrémité supérieure du chevron régulier (G) est fixée au support de chevron (O-3) à l'aide des boulons (Bb-3). L'extrémité inférieure du chevron régulier (G) est fixée entre chaque panneau à l'aide des boulons (Z-3).  
Remarque : N'utilisez PAS de perceuse électrique, serrez les boulons manuellement.

## Étape 15

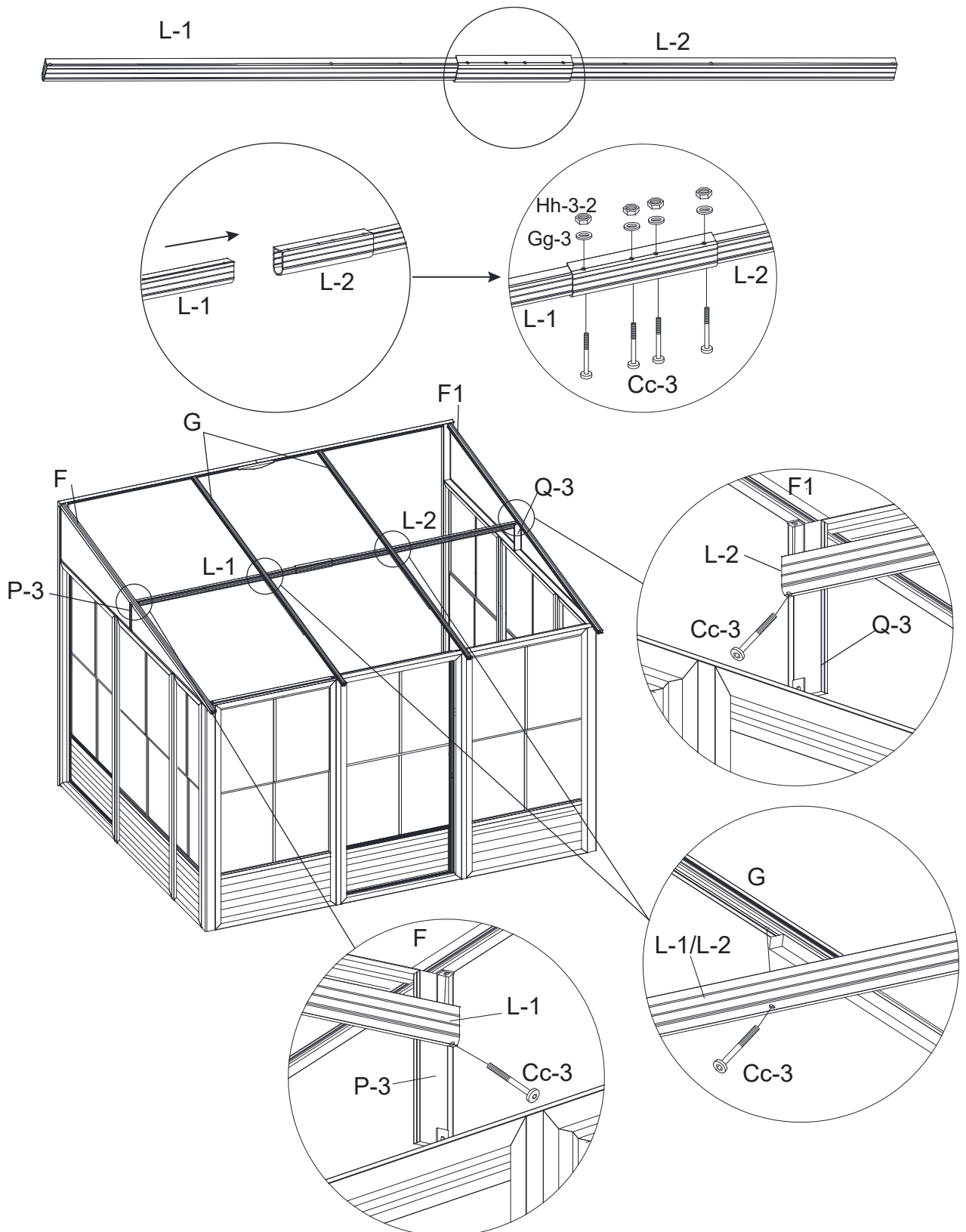

- 15.1. Assemblez les traverses (L-1/L-2) à l'aide des boulons (Cc-3) et des écrous (Hh-3-2).
- 15.2. Fixez les traverses assemblées (L1/L2) au côté gauche du chevron (F) et au côté droit du chevron (F1) et à travers le le joint de pignon gauche (P-3) et le joint de pignon droit (Q-3) . Connectez le milieu au chevron régulier (G) et fixez-les à l'aide des boulons (Cc-3).

## Étape 16

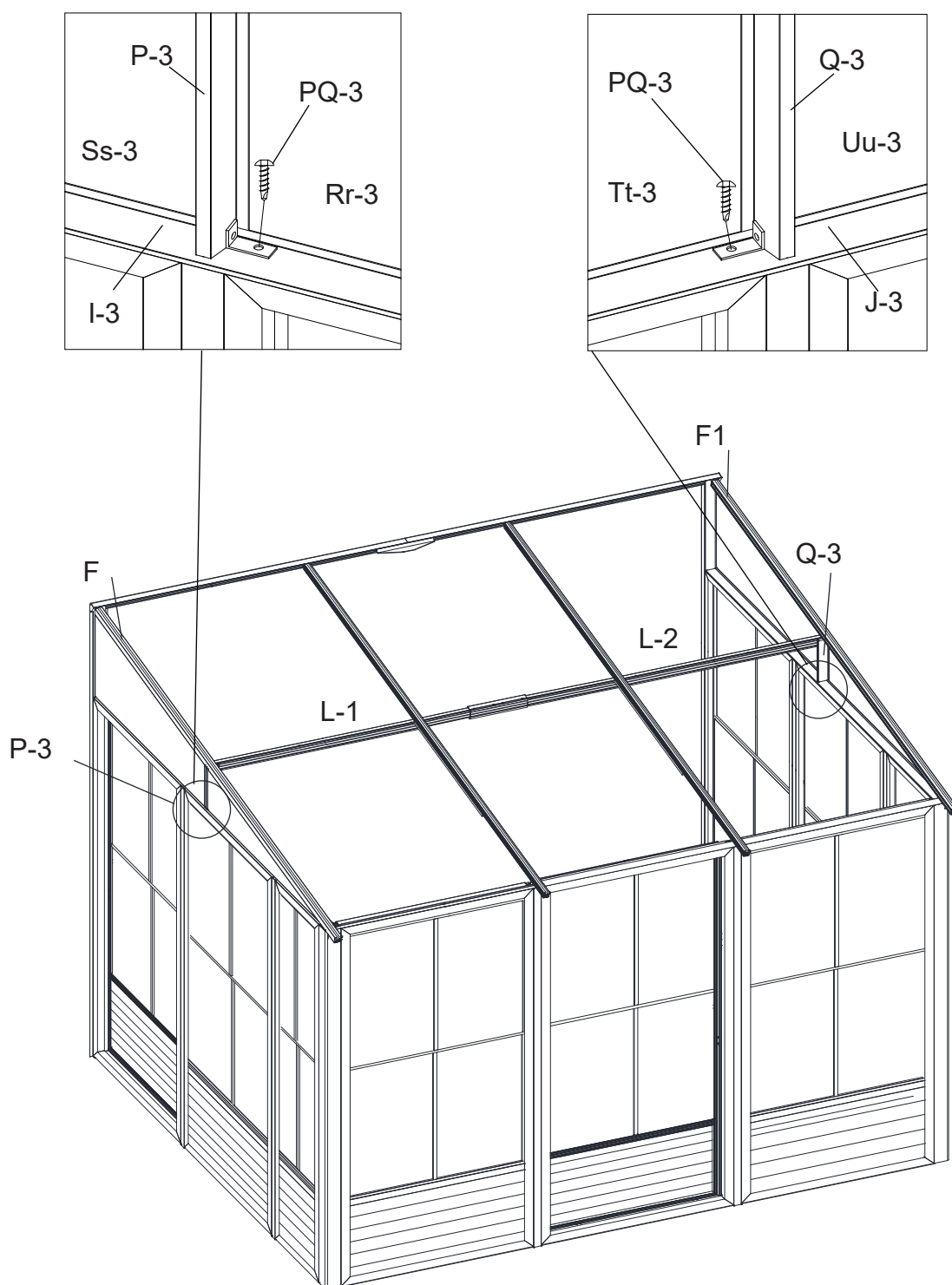

16. Fixez les joints de pignons (P-3/Q-3) au récepteurs latéraux (I-3/J-3) respectivement à l'aide des vis auto-perçantes (PQ-3).

## Étape 17

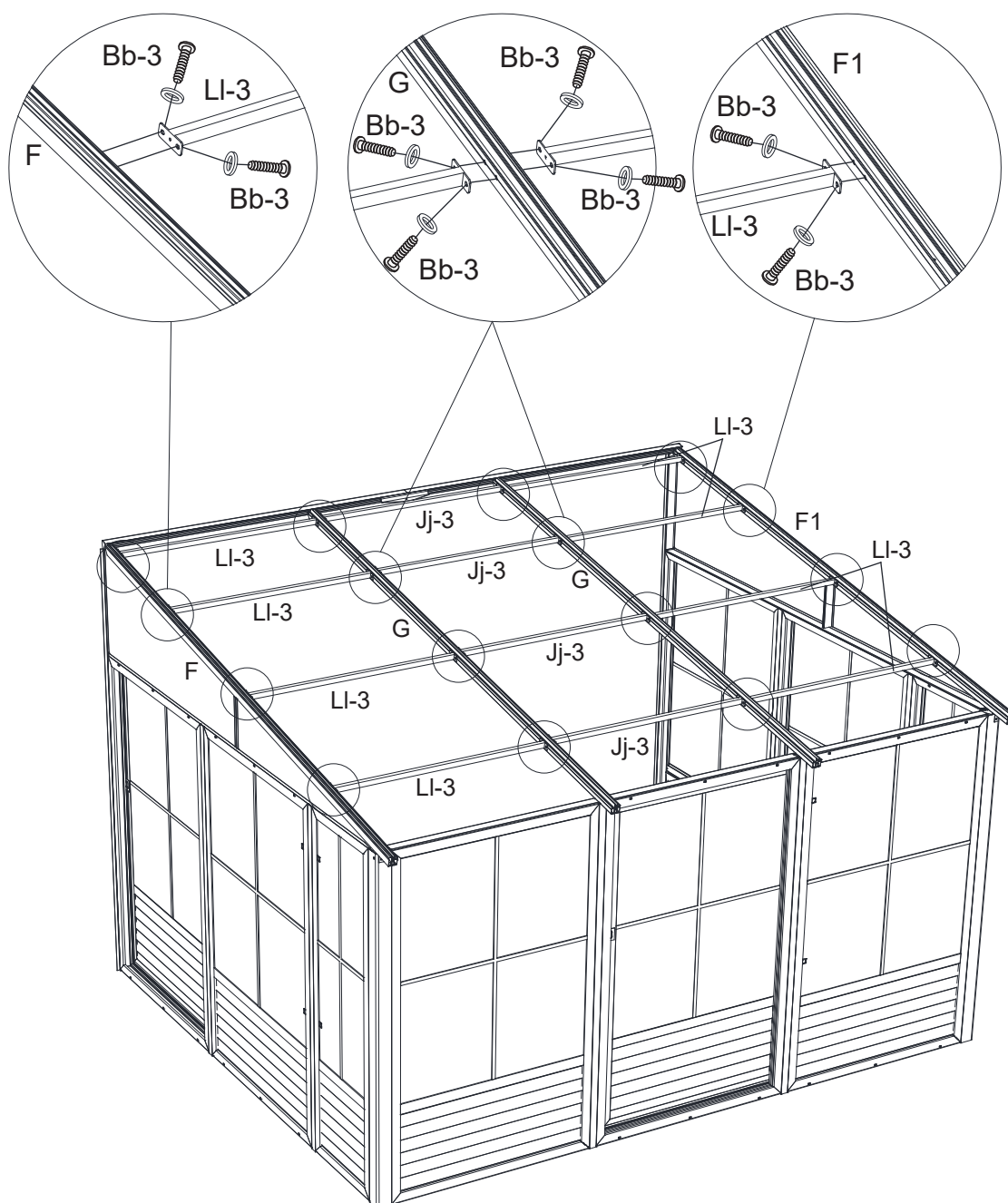

17. Connectez les deux tubes latéraux (LI-3) et le tube central (Jj-3) aux chevrons (F/F1/G). Fixez-les avec les boulons (Bb-3) et les rondelles (Gg-3) respectivement.

## Étape 18

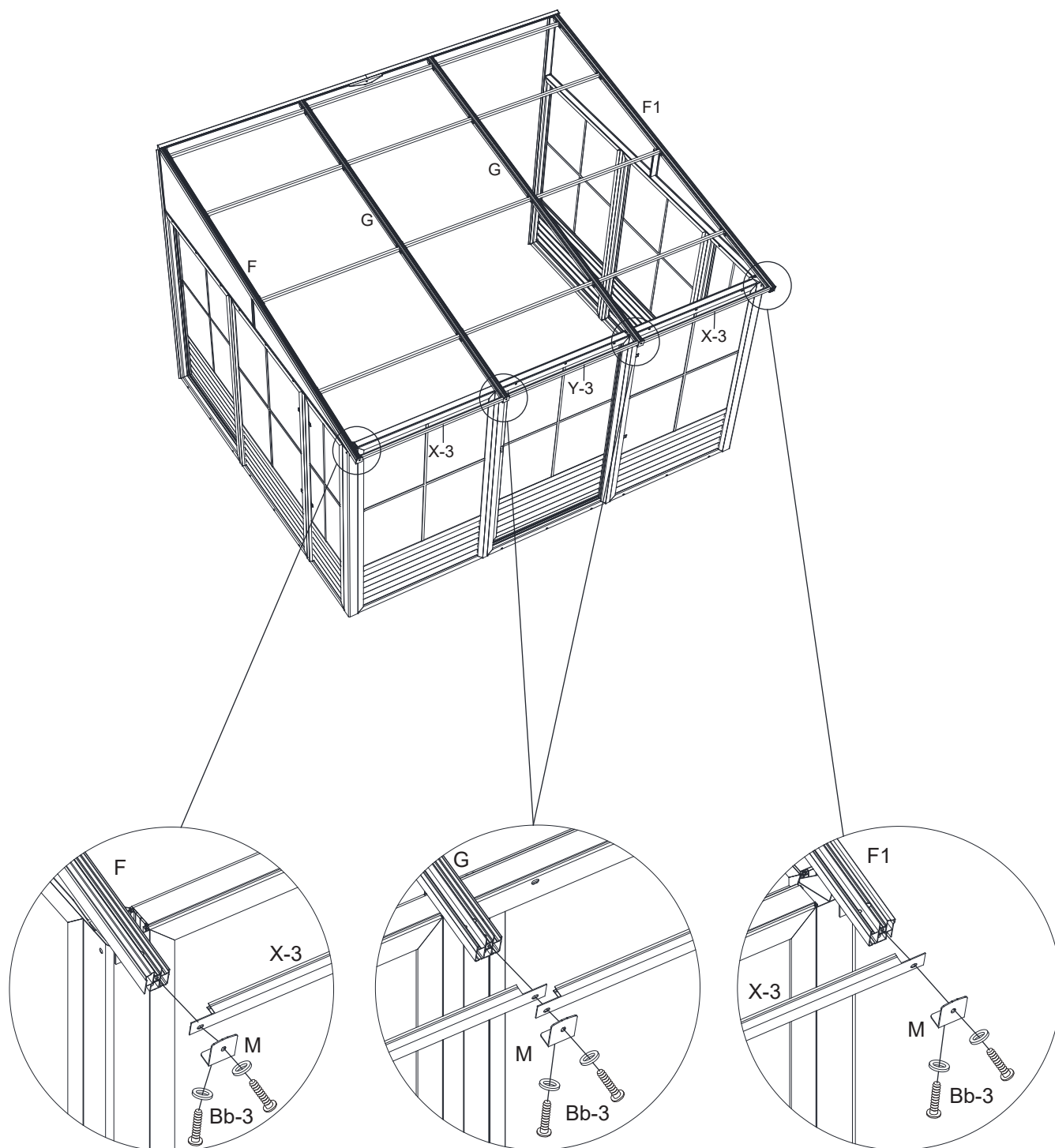

18. Fixez le joint de la poutre (M), le joint (X-3/Y3) et les chevrons (F/F1/G) à l'aide des boulons (Bb-3) et des rondelles (Gg-3).

## Étape 19

Remarque : Les panneaux de toit sont assemblés les uns entre les autres, comme indiqué sur l'image.

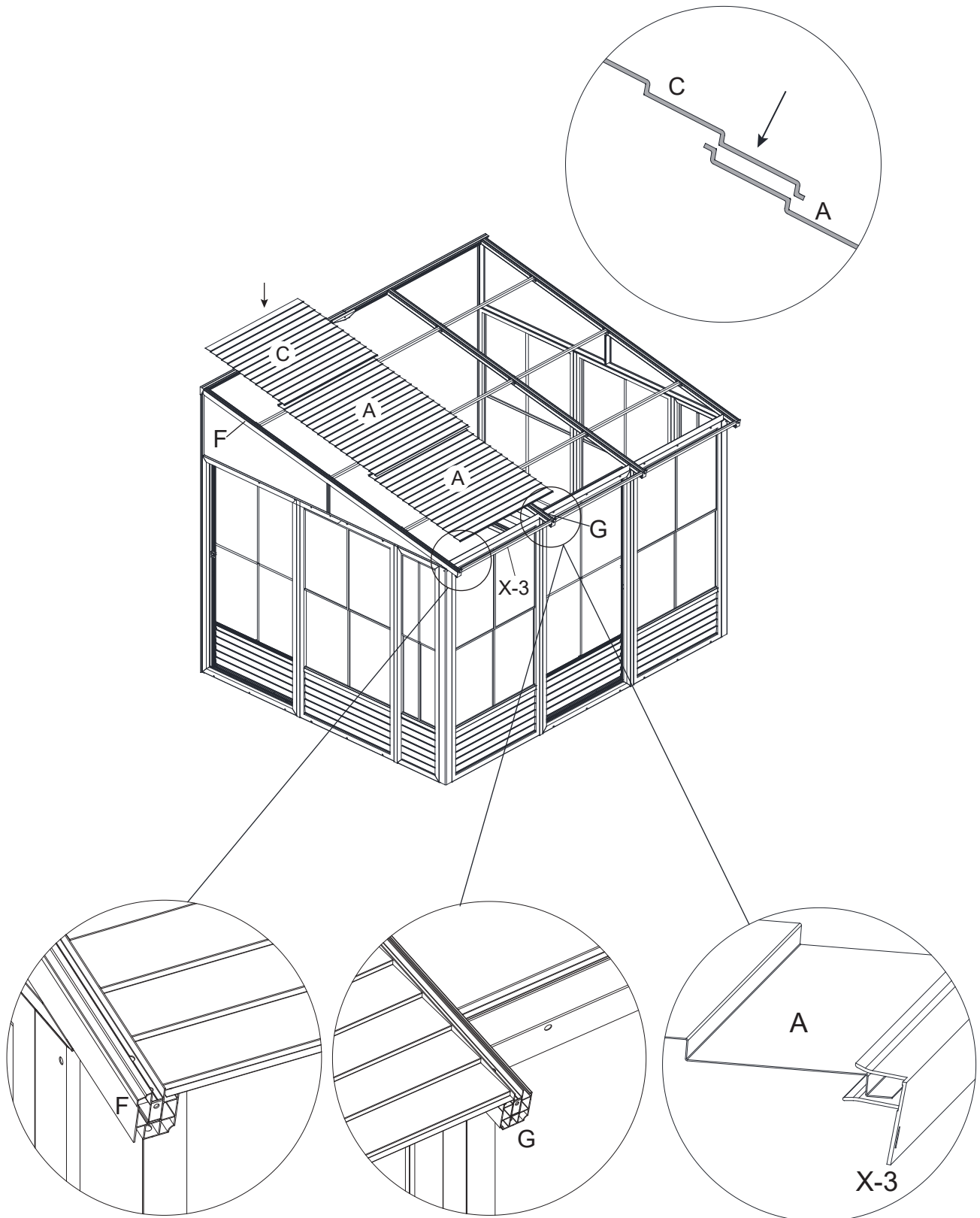

19. Fixez les panneaux de toit (A/C) aux chevrons (F/G) dans l'ordre.

## Étape 20

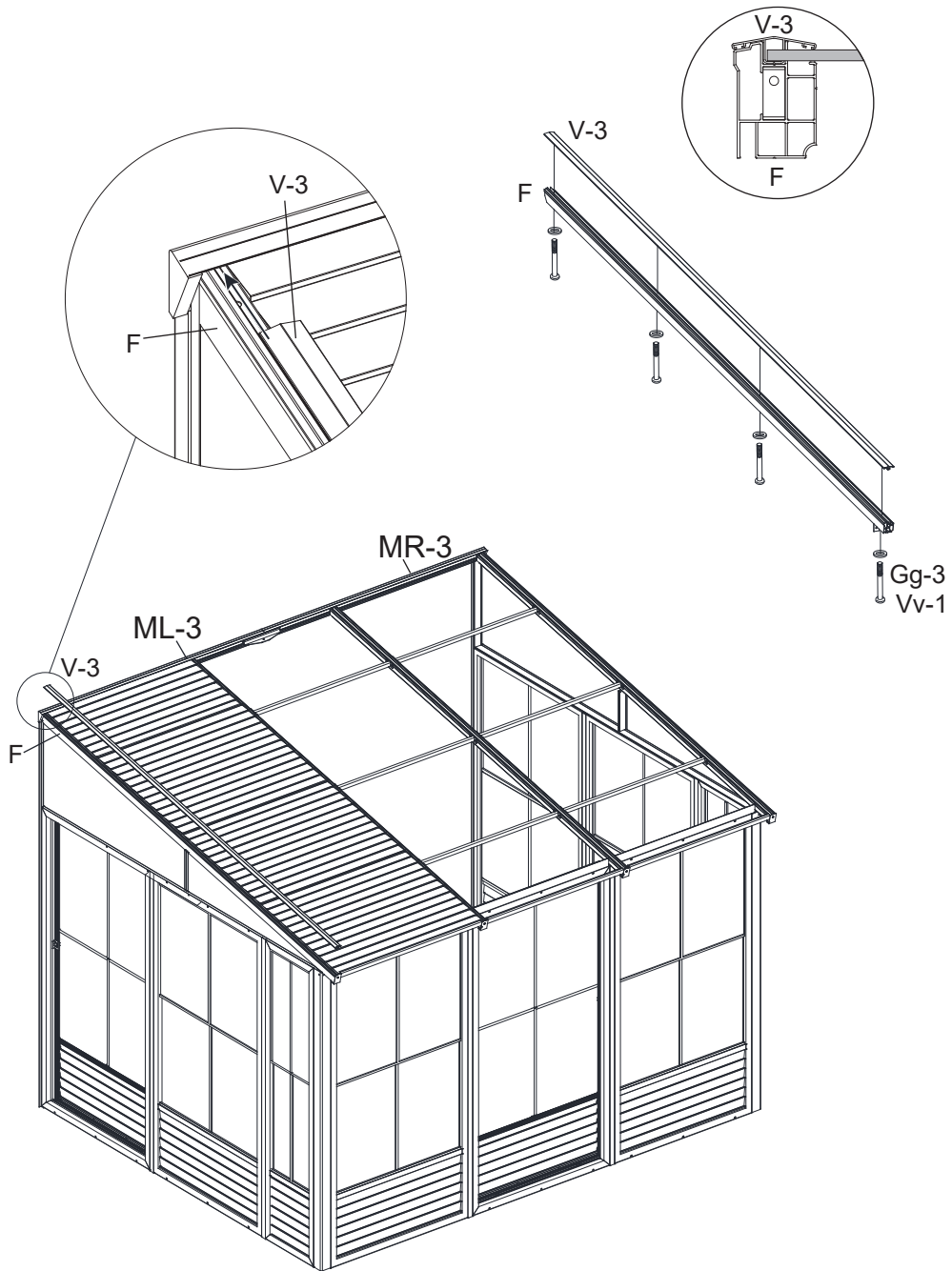

20. Fixez la barre de toit flexible (V-3) en insérant une extrémité dans le rail mural (ML-3) et en la reliant au chevron latéral gauche (F). Fixez à l'aide des boulons (Vv-1) et des rondelles (Gg-3).

## Étape 21

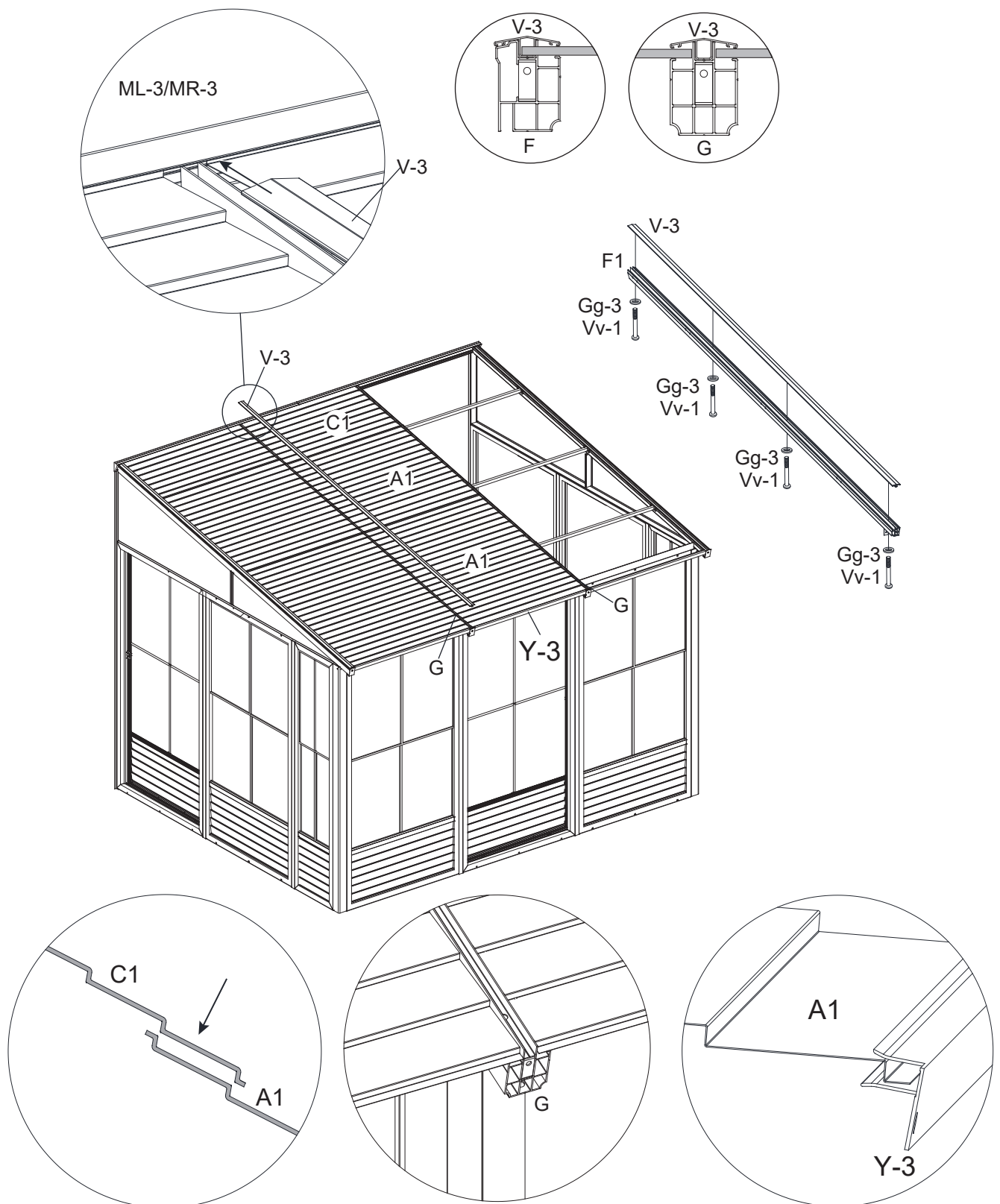

Remarque : Les panneaux de toit sont assemblés les uns entre les autres, comme indiqué sur l'image.

- 21.1. Fixez les panneaux de toit (A1/C1) aux chevrons régulier (G) dans l'ordre.
- 21.2. Fixez la barre de toit flexible (V-3) en insérant l'extrémité dans le rail mural (ML-3) et en la reliant aux chevrons régulier (G), en la fixant à l'aide des boulons (Vv-1) et des rondelles (Gg-3).

## Étape 22

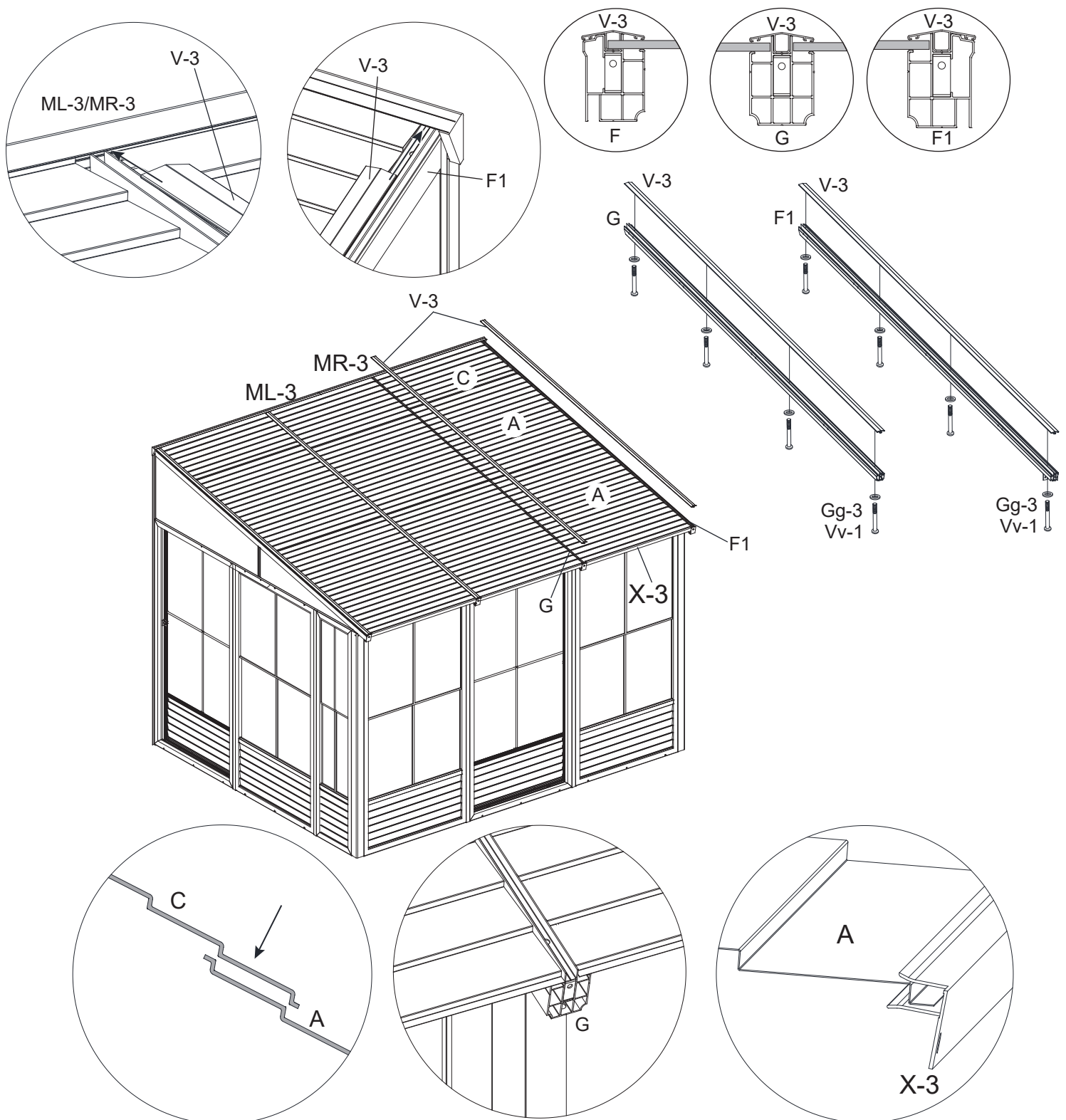

Remarque : Les panneaux de toit sont assemblés les uns entre les autres, comme indiqué sur l'image.

- 22.1. Fixez les panneaux de toit (A/C) aux chevrons régulier (G/F1) dans l'ordre.
- 22.2. Fixez la barre de toit flexible (V-3) en insérant l'extrémité dans le rail mural (MR-3) et en la reliant aux chevrons régulier (G), en la fixant à l'aide des boulons (Vv-1) et des rondelles (Gg-3).

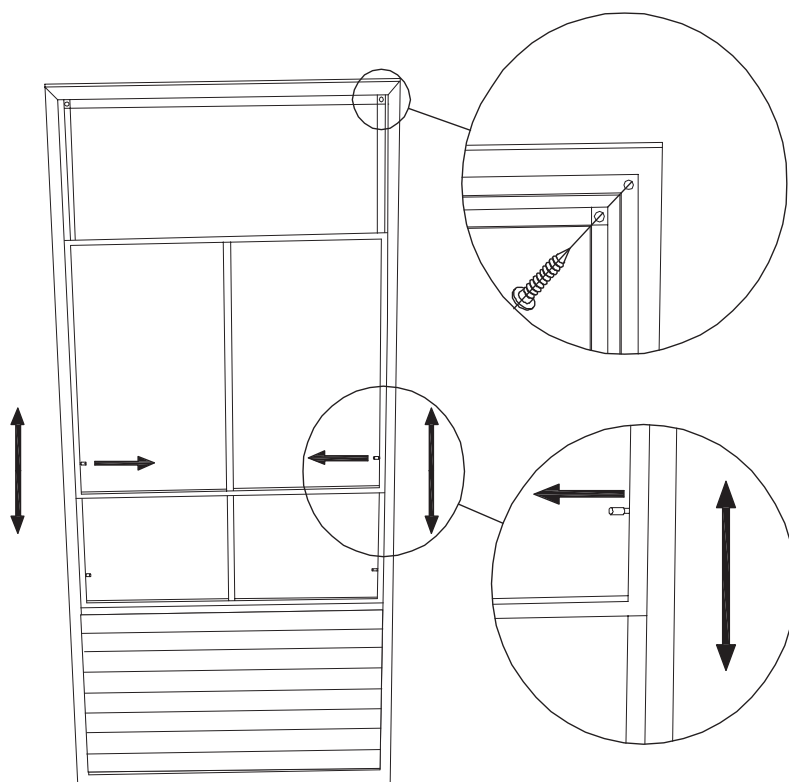

### **REMARQUES :**

Pour retirer la moustiquaire, retirez les deux vis situées en haut du cadre, puis tirez latéralement jusqu'à l'extrémité opposée de la poignée pour la retirer. Pour retirer les panneaux de ventilation, poussez ou tirez d'un côté, en vous assurant que la goupille de verrouillage ne soit pas bloquée, puis retirez doucement les panneaux.

### **INSTRUCTIONS DE NETTOYAGE :**

Utilisez uniquement de l'eau savonneuse douce et tiède. N'utilisez aucun produit de nettoyage fort ou abrasif.

### **AVERTISSEMENT:**

- 1) N'utilisez jamais votre barbecue ou tout autre produit inflammable à l'intérieur du solarium.
- 2) Enlevez la neige de la toit.

## **\*Suggestions**

The below mentioned are only suggestions in order to permit drainage, these will vary depending on your flooring – material, flatness and slope.

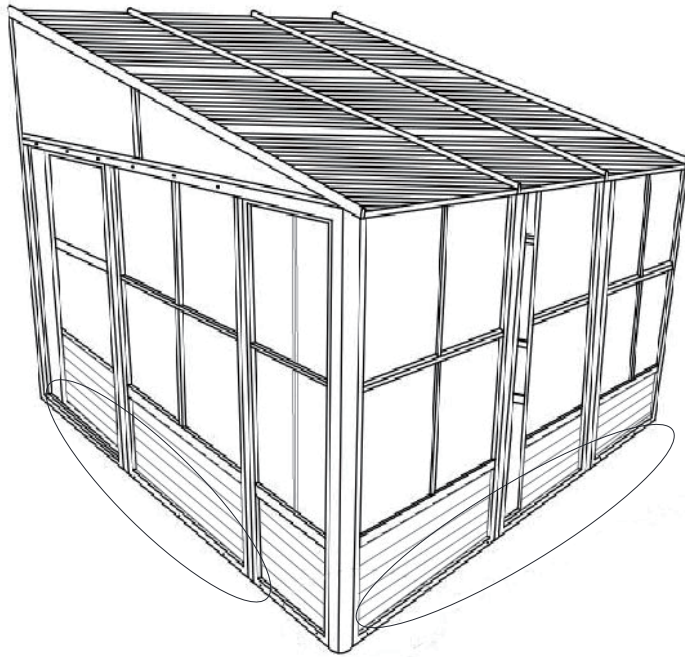

### **For Concrete Flooring**

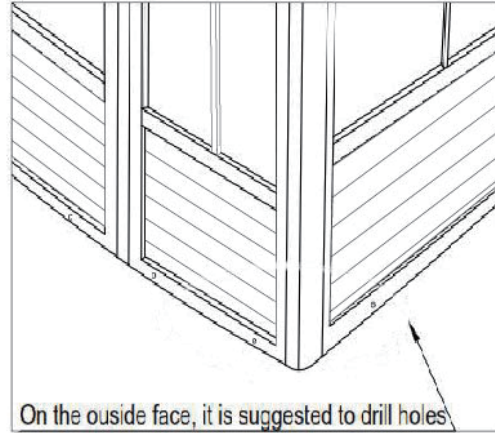

On the outside face, it is suggested to drill holes at the bottom end of the panels to permit drainage when installing on concrete floor

### **For Wooden Deck**

**Drill through the wooden deck where drain holes are located to permit drainage**

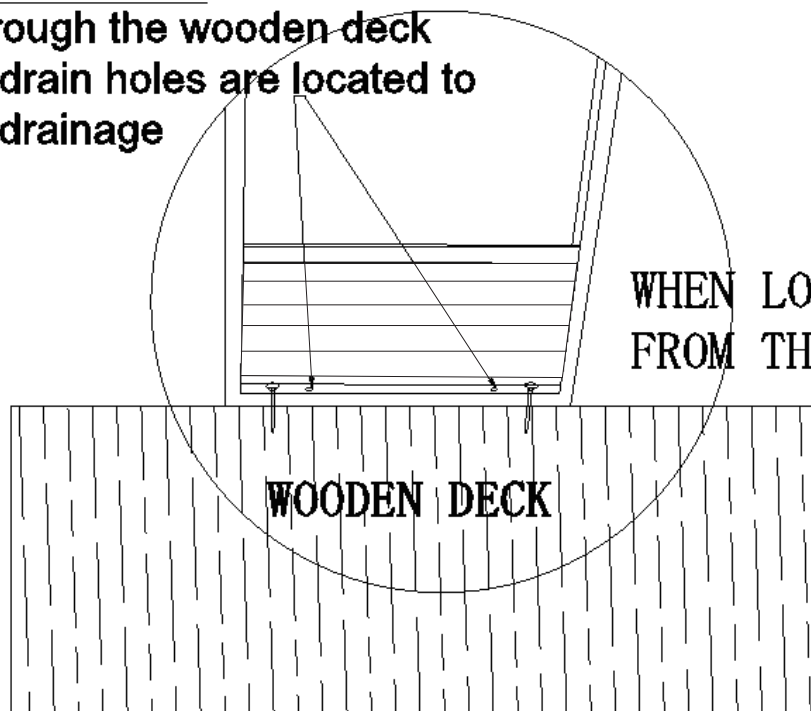

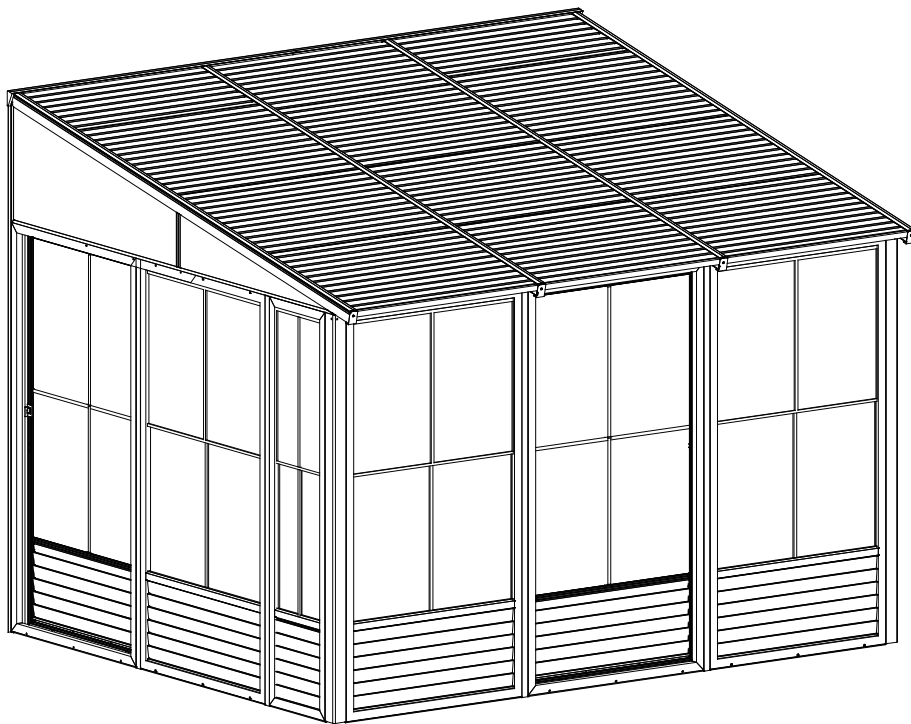
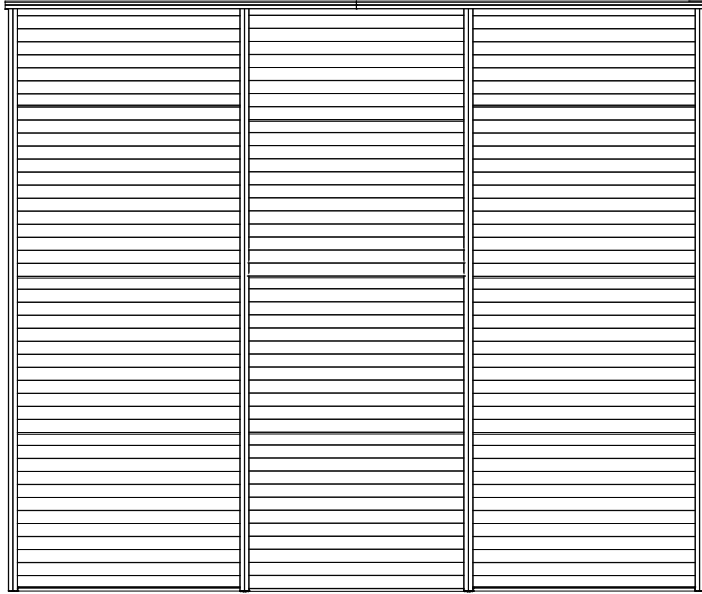

# GARANTIE

Inspectez soigneusement le contenu de l'emballage afin de vérifier si certaines composantes sont manquantes ou endommagées. Advenant que certaines pièces soient manquantes ou endommagées, **ne retournez pas le produit à l'endroit où vous l'avez acheté**; contactez plutôt le département d'expérience client de Gazebo Penguin

Montréal : (514) 276-3485

Ailleurs au Canada et États-Unis : 1-800-737-7174

info@gazebopenguin.com

Ce produit a été conçu et fabriqué afin de répondre aux normes les plus exigeantes en matière de qualité et de durabilité.

Sous réserve de la section « limitations et exclusions à la garantie » ci-dessous, il est garanti contre les défauts matériels ou de fabrication:

- **1 AN SUR LES DÉFAUTS MANUFACTURIERS**

Advenant que le produit soit endommagé ou que la période de garantie soit expirée, veuillez contacter le département d'expérience client de Gazebo Penguin afin d'obtenir une liste complète des pièces de remplacement et des prix.

## LIMITATIONS ET EXCLUSIONS À LA GARANTIE

- 1. Dommages non couverts:** Cette garantie ne couvre pas les dommages causés par le vent, la chute d'objets, le feu, les animaux, la végétation, le vandalisme, les conditions climatiques extrêmes, ni les effondrements dus à l'accumulation de neige et de glace.
- 2. Entretien du toit:** Le toit doit rester libre de toute accumulation de neige ou de glace. Ces accumulations doivent être retirées en sections de cinq pieds (5) à la fois, de droite à gauche. Les dommages causés par un défaut d'entretien du toit ne sont pas couverts par la garantie.
- 3. Retrait de neige et de glace:** Le retrait de neige ou de glace depuis l'intérieur du produit est interdit, car il peut causer des dommages au produit.
- 4. Positionnement:** Il est déconseillé de placer le produit à proximité d'immeubles ou d'arbres, car la neige ou la glace peut glisser et s'accumuler sur le toit, provoquant un poids excessif.
- 5. Installation:** La garantie est valide uniquement si le produit est installé conformément aux instructions fournies par Gazebo Penguin. Une installation incorrecte, notamment un ancrage inadéquat, annule la garantie.
- 6. Infiltration d'eau:** Des infiltrations d'eau peuvent survenir en cas de fortes pluies. Consultez le manuel d'instructions pour les positions des fenêtres et les informations sur l'évacuation de l'eau.
- 7. Clause de remplacement:** Nous nous réservons le droit de réparer ou remplacer tout produit ou pièce défectueuse, à notre seule discrétion.
- 8. Modifications:** Toute modification ou ajout au produit annule la garantie.



# MANUEL D'INSTRUCTIONS INSTRUCTION MANUAL

---

**Florence Solarium 10 Pl. X 12 Pl. - Toit d'Acier**  
**Florence Solarium 10 FT. X 12 FT. - Metal Roof**

---

sku: W1209MR-GP-12		
sku: W1209MR-GP-32		
sku: W1209MR-GP-42		

---

**DO NOT DESTROY THE BOXES UNTIL COMPLETELY ASSEMBLED  
FOR FUTURE REFERENCE,  
TAKE PICTURES OF ALL SIX SIDES OF EACH OF THE BOXES UPON RECEIPT.  
PLEASE VERIFY THE CONTENT OF EACH BOX AGAINST THE LIST OF PARTS**

**10ft x 12ft / 3.04m x 3.65m Meters Solarium**

**Instruction Manual**

**IMPORTANT: RETAIN FOR FUTURE REFERENCE, READ CAREFULLY**

**Consult with your local governing authority / local municipal codes regarding installation of temporary structures before purchase or assembly. Some jurisdictions may require permits for, or otherwise regulate, installation and use.**

For assistance with assembly, installation, parts, or customer service, contact Gazebo Penguin Customer Service Department at the numbers listed below (English & French, Mon-Fri 8:00 AM to 4:00 PM EST):

**Montreal:** (514) 276-3485

**Elsewhere in Canada and the US:** 1-800-737-7174

**WARNING:**

- For outdoor use.
- Snow should be regularly cleared from the roof and not allowed to accumulate.
- Retain your **proof of purchase** for warranty purposes. Also keep the **original boxes** until the installation is complete and correct.
- The unit may take more than 4 hours and 3 people are required for this assembly.



**PRIOR TO ASSEMBLY:**

- Please don't destroy boxes until completely assembled.
- The foundation must be level, flat, and solid, such as concrete or asphalt.
- Keep away from overhead utility lines, tree branches, and other structures.
- Check for underground pipes or wires if digging or drilling is required.
- Do not install near roof lines or other structures that could shed snow, ice, or excessive rain run-off onto the roof top.
- Assemble the structure as close to its final location as possible.
- It is recommended to wear safety gloves, safety glasses, and hard hats for installation.
- Do not hang from, climb on, or stand on the structure or roof.
- Before assembly, read instructions and check that all parts are present in the boxes. If any parts are missing, refer to warranty information.
- A 6ft (1.8m) stepladder, Phillips screwdriver, tape measure, level, mallet, and a tarp to place parts on will be required for assembly (not included).
- Remove top protective film from roof panels prior to assembly; **DO NOT** remove bottom protective film until ready to insert roof panels, so as to identify which side is on top.

**ANCHORING INSTRUCTIONS:**

- Proper anchoring of the frame to the base and the wall is required for safety.
- Any structure not anchored securely has the potential to fly away during high wind causing damage and safety hazard.
- How the item is anchored, and the hardware and tools required, will vary based upon the set up location and are not provided.
- Please check with your local hardware store if for the appropriate anchors for your surface.
- Do not anchor to pavers / pavement slabs because they are not a solid foundation.
- Periodically check the anchors to ensure they remain secure

**CARE AND MAINTENANCE:**

- In case of a defective or damaged part, or for any other questions concerning the product, please contact the manufacturer directly.
- Please have the parts list and part numbers on hand when ordering or requesting replacement parts.

**ROOF PANELS:**

- Gently clean with an environmentally-friendly soap solution and water using a sponge or washcloth.
- Do not use abrasive materials, wire brushes, chemicals, harsh cleaners, or bleach.
- Rinse using a garden hose and air dry. If removed, ensure thoroughly dry prior to storage.
- Do not use pressure washer.

**STRUCTURE:**

- Gently clean with an environmentally-friendly soap solution and water using a sponge or washcloth.
- Do not use abrasive materials, wire brushes, chemicals, harsh cleaners, or bleach.
- Rinse using a garden hose and air dry.
- Do not use pressure washer.
- If there are nicks, chips, and/or scratches see the part # of the paint in the parts list to obtain a matching touch-up paint.

**Note: The Dimensions are approximate**



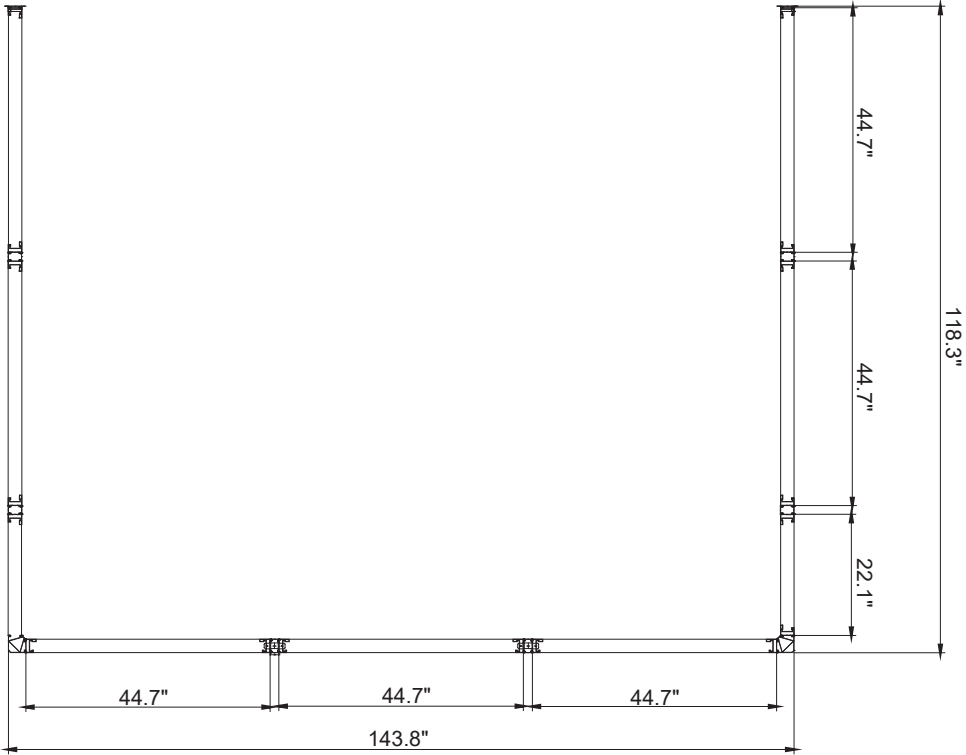



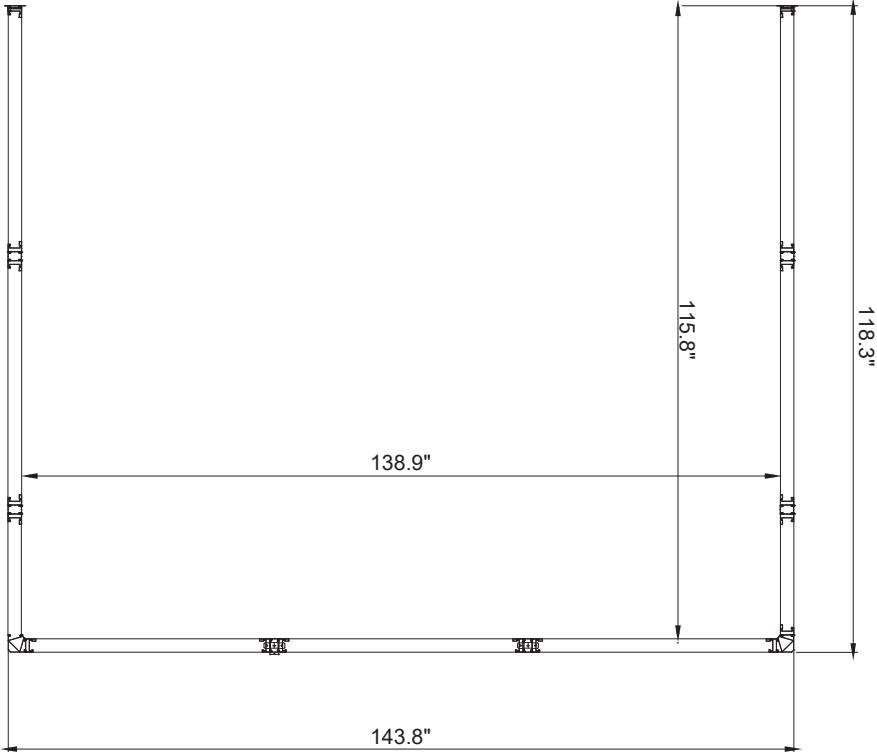



10X12 ADD A ROOM  
PANNEAUX A LA BASE  
PANELS AT BASE

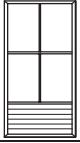

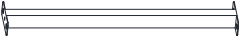
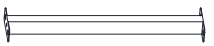
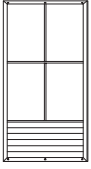



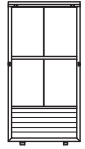
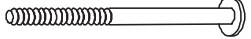
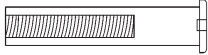
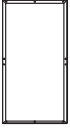
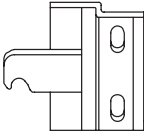
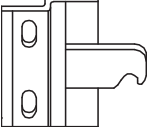

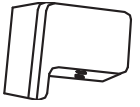
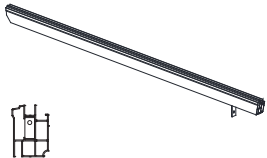
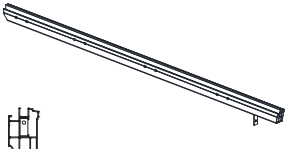

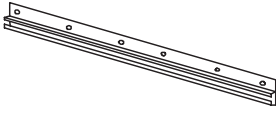
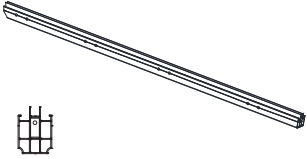
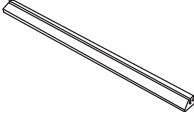





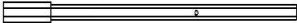
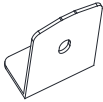



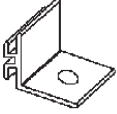





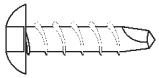

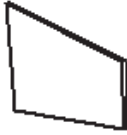
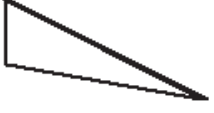
10X12 ADD A ROOM  
AU REBORD DU TOIT  
ROOF OVERHANG

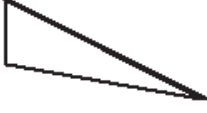

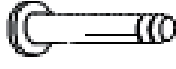
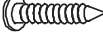
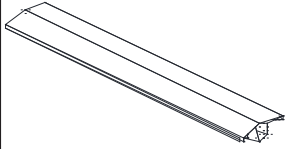

## 10 x 12 solarium

DESCRIPTION	PACKED IN BOX	QTY	DRAWING	DESCRIPTION	PACKED IN BOX	QTY	DRAWING
23-316 ROOF PANEL (47.2"x44.5") A	1	4		23-317 ROOF PANEL (45.6" x 44.5") A1	1	2	
23-093 REGULAR FRAME A-3	2	2		23-318 HALF FRAME A-3 1/2	2	1	
	3	1			3	1	
23-239 SIDE SUPPORT ED TUBE (46") LI-3	4	8		23-243 MIDDLE SUPPO RTED TUBE (44.4") Jj-3	4	4	
23-094 FRAME NEXT TO DOOR B-3 (Has more holes)	2	1		25-114 BOLT Bb-3	4	76	 (M6*16mm)
	3	1					
23-319 ROOF PANEL (47.2" x 41.8") C	1	2		23-320 ROOF PANEL (45.6" x 41.8") C1	1	1	
23-095 SLIDING DOOR C-3	2	1		25-115 BOLT Cc-3	4	20	 (M6*73mm)
	3	1					
25-117 FEMALE BOLT Cc-3-2	4	12	 M5*60mm	10-499 SLIDING DOOR FRAME D-3	2	1	
					3	1	
08-169 LEFT DOOR LATCH Dd-L-3	4	2		08-165 RIGHT DOOR LATCH Dd-R-3	4	2	
11-544 CONNECTING PIECE E-3	4	12		08-138 PLASTIC STOPPER H-3	4	4	
23-321 LEFT ROOF BAR (124.1") F	4	1		23-322 RIGHT ROOF BAR (124.1") F1	4	1	

DESCRIPTION	PACKED IN BOX	QTY	DRAWING	DESCRIPTION	PACKED IN BOX	QTY	DRAWING
23-241 TOP DOOR RAIL (90.4") F-3	4	2		23-323 REGULAR ROOF BAR (124.1") G	4	2	
11-546 BOTTOM DOOR RAIL (88.5") G-3	4	2		08-187 WASHER Gg-3	4	96	
10-500 LEFT SIDE RECEIVER I-3	4	1		12-161 NUT Hh-3-2	4	4	
10-501 RIGHT SIDE RECEIVER J-3	4	1		10-502 CORNER CONNECTOR K-3	4	2	
23-324 LEFT CROSSBEAM (59.8") L-1	4	1		23-325 RIGHT CROSSBEAM (83") L-2	4	1	
23-246 TOP BEAM SEAL M	4	4		23-314 WALL TRACK (72.5") ML-3	4	1	
23-315 WALL TRACK (72.5") MR-3	4	1		10-505 TRACK JOINT N-3	4	1	
08-134 UPPER DOOR RAIL END CAP Nn	4	4		10-506 RAFTER BRACKET O-3	4	2	
08-135 SCREW Oo-3	4	4	 (M4*12mm)	10-507 LEFT GABLE JOINT P-3	4	1	
25-203 SIDE WIND SHIELD (45.9") Zz-3	4	2		25-204 MIDDLE WIND SHIELD (44.3") Yy-3	4	1	

DESCRIPTION	PACKED IN BOX	QTY	DRAWING	DESCRIPTION	PACKED IN BOX	QTY	DRAWING
13-045 SELF-TAPPING SCREW PQ-3	4	2		10-508 RIGHT GABLE JOINT Q-3	4	1	
25-205 LEFT BACK GABLE PANEL Rr-3	2	1		25-206 LEFT FRONT GABLE PANEL Ss-3	2	1	
25-207 RIGHT BACK GABLE PANEL Tt-3	2	1		15-125 MOUNTING BRACKET U-3 (ASSEMBLED ON ROOF BAR G)	4	2	
25-208 RIGHT FRONT GABLE PANEL Uu-3	2	1		23-256 LEFT WALL GUIDE (94.3") Vv-3	4	1	
25-118 BOLT Ww	4	12	 M5*15mm	23-257 RIGHT WALL GUIDE (94.3") Ww-3	4	1	
10-529 SCREW FOR FIXING TO WALL Xx-3	4	18		08-156 SCREW Z-3	4	4	 M4*16mm
23-326 ROOF BAR PRE SSBOARD (124 ") V-3	4	4		23-258 MIDDLE SEALING (48 ") Y-3	4	1	
23-259 SIDE SEALING (49.5") X-3	4	2		21-040 BOLT Vv-1	4	16	 M6*65mm
23-007 PLASTIC PLUG Kk	4	4					

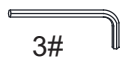
DESCRIPTION	PACKED IN BOX	QTY	DRAWING	DESCRIPTION	PACKED IN BOX	QTY	DRAWING
23-215 Allen wrench QQ	4	1	 4#	25-198 Spring leaf PP	4	40	
23-223 Allen wrench RR	4	1	 3#				

REMOVE STICKER AFTER ASSEMBLY

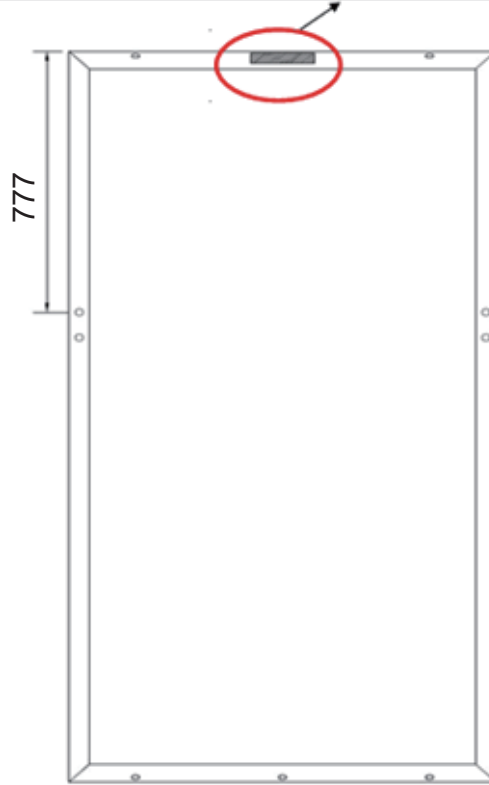
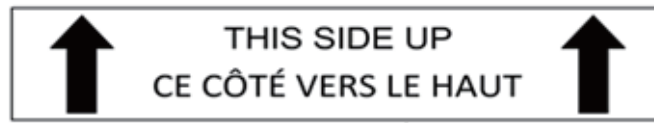

D-3 FRAME

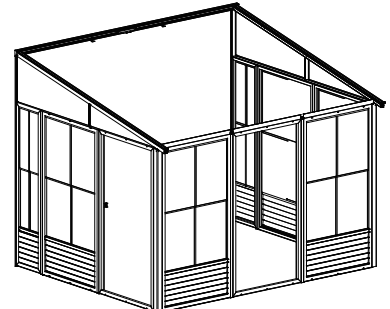
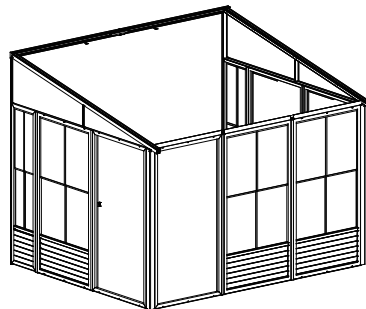
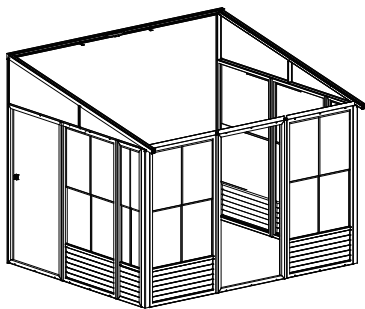

**SHOWN ARE FEW POSSIBILITIES**

**THE SLIDING DOOR CAN BE PLACED IN ANY LOCATION AS LONG AS THE FRAME NEXT TO DOOR IS BESIDEIT.**

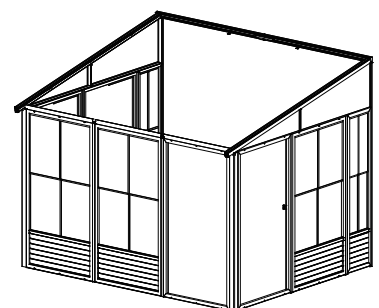
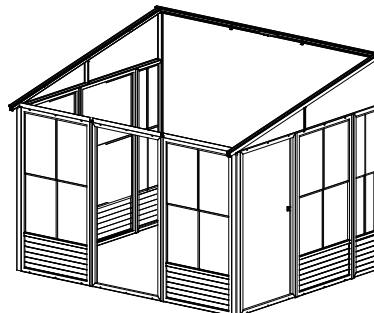
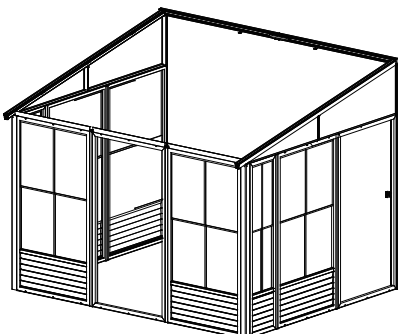

## **TOOLS REQUIRED:**

- Screwdriver (Philips #2)
- Knife
- File (smooth)
- Needle-nosed pliers
- Rubber mallet
- Step ladder (minimum 6' in height)
- Spatula
- Power drill
- Tube of silicon
- Drill bit 5/16" cement (according to surface)
- Round file + flat
- 2"x4"x8" wood

## **BEFORE STARTING:**

Ensure that you have a solid base, such as concrete or wooden deck, not slanted more than 1" per 8'. Avoid installing unit adjacent to trees or a sloped roof, as snow and ice may slide onto the solarium and cause it to collapse.

Please don't destroy boxes until completely assembled.

## **Door placement direction:**

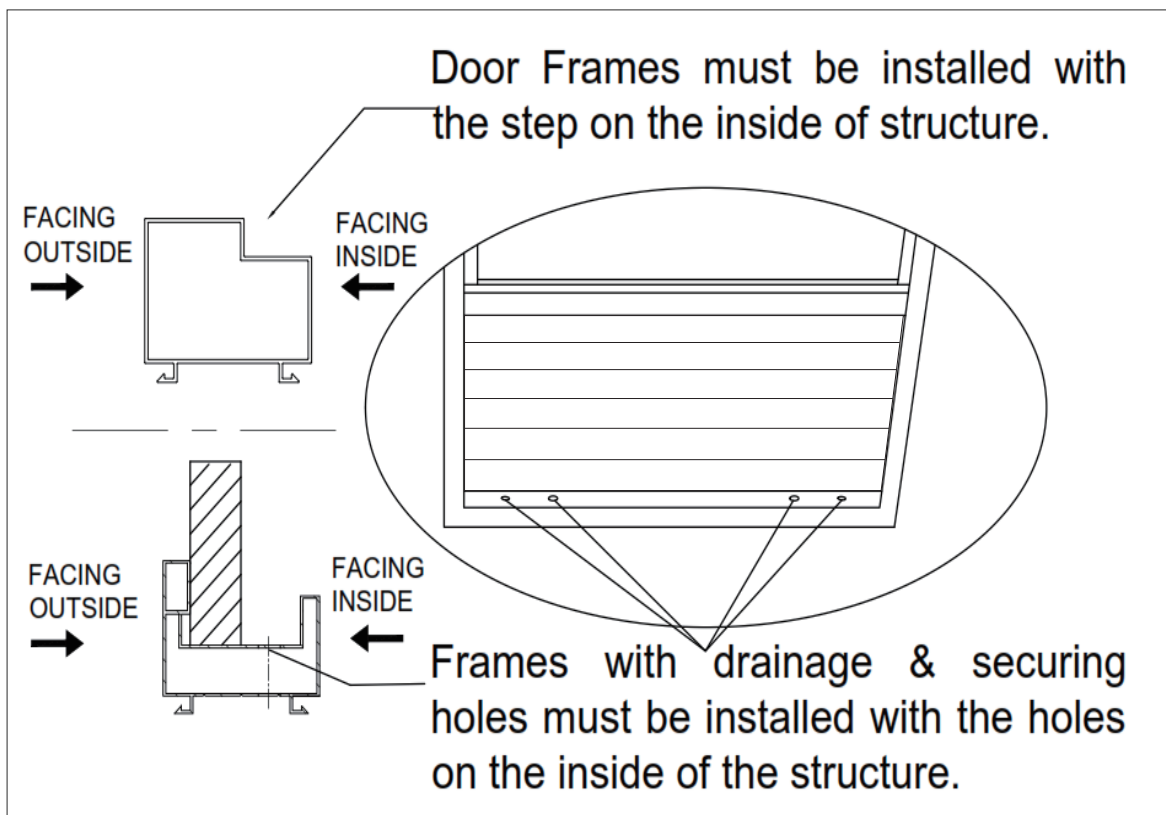

## **STEP #1**

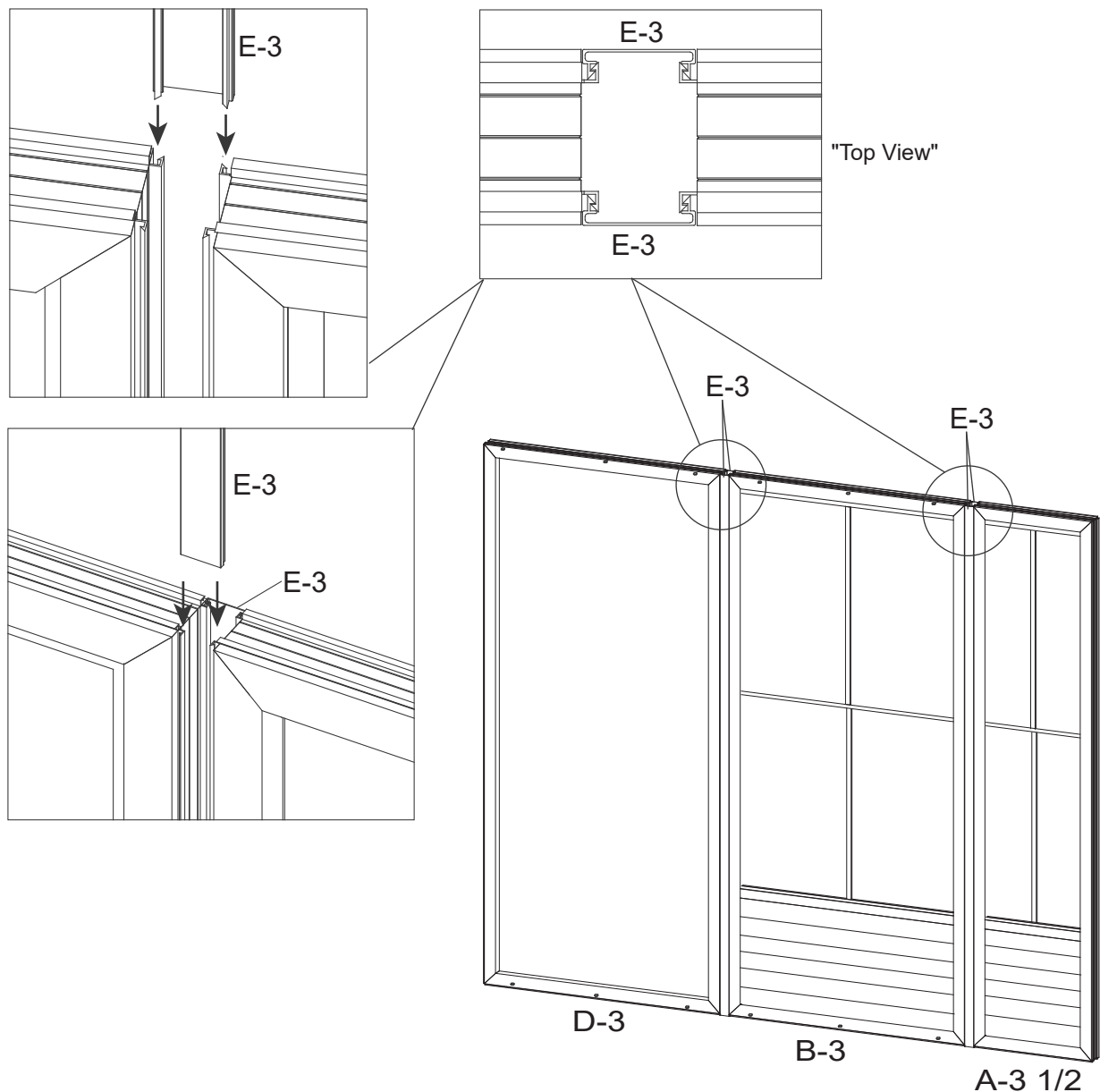

1.1 Decide the position of the door frames before assembly according to where you intend to slide the door. At the front of the solarium, use frame (D-3) for the opening of the door and Frame Next to Door B-3 for the direction of the door when open.

1.2 Align the Sliding Door Frame (D-3) with the Frame Next To Door (B-3), use the Connecting Piece (E-3) to insert the Sliding Door Frame (D-3) and the inside of the Frame Next to Door (B-3), connect the outside in the same way. Then align the Door (B-3) with the Frame Next To Door (A-3 1/2), use the Connecting Piece (E-3) to insert the Frame Next to Door (B-3) and the inside of the door (A-3 1/2), connect the outside in the same way.

### **NOTE:**

When sliding the Connectors (E-3), shake the frame so that they will slide easily. Do not use tools to force. If needed, clean the paint with a file and make sure the ends of the frame and joints are not bent or warped. If so, use the needle-nosed pliers to straighten.

**STEP #2**

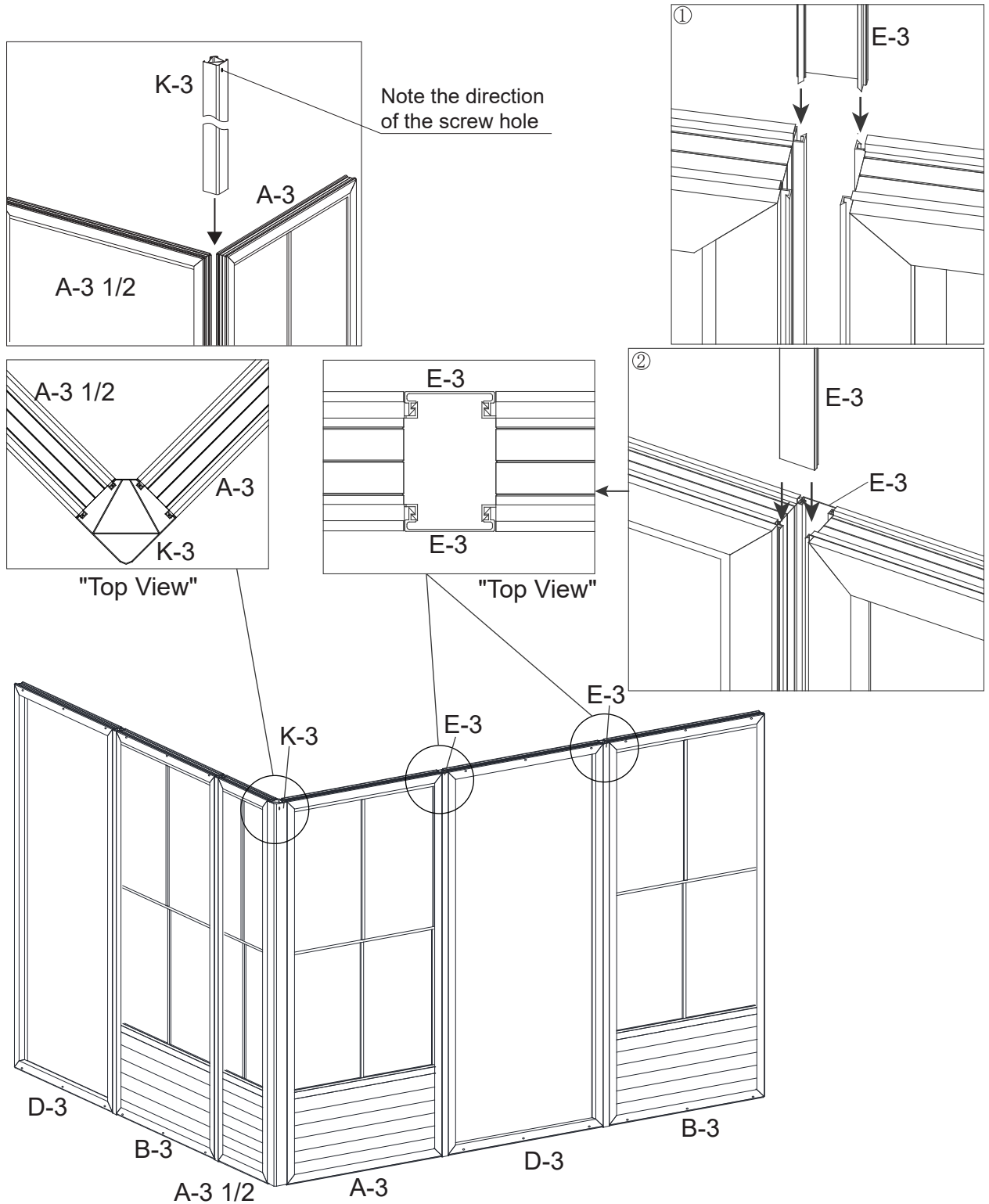

2. Connect the Regular Frame (A-3), Sliding Door Frame (D-3) and Frame Next To Door (B-3) with Corner Connector (K-3) and ConnectingPiece (E-3) connected together, Corner Connector (K-3) with bolt holes facing up and out. Sliding Door Frame (D-3) with sticker with arrow pointing upwards.(See sketch on page 8)

**NOTE:** When placing the door frame opening, make sure the inserts on the frame are on the inside and on the upper half of the frame of the solarium because the door will be set on the inside due to clearance.

**STEP #3**

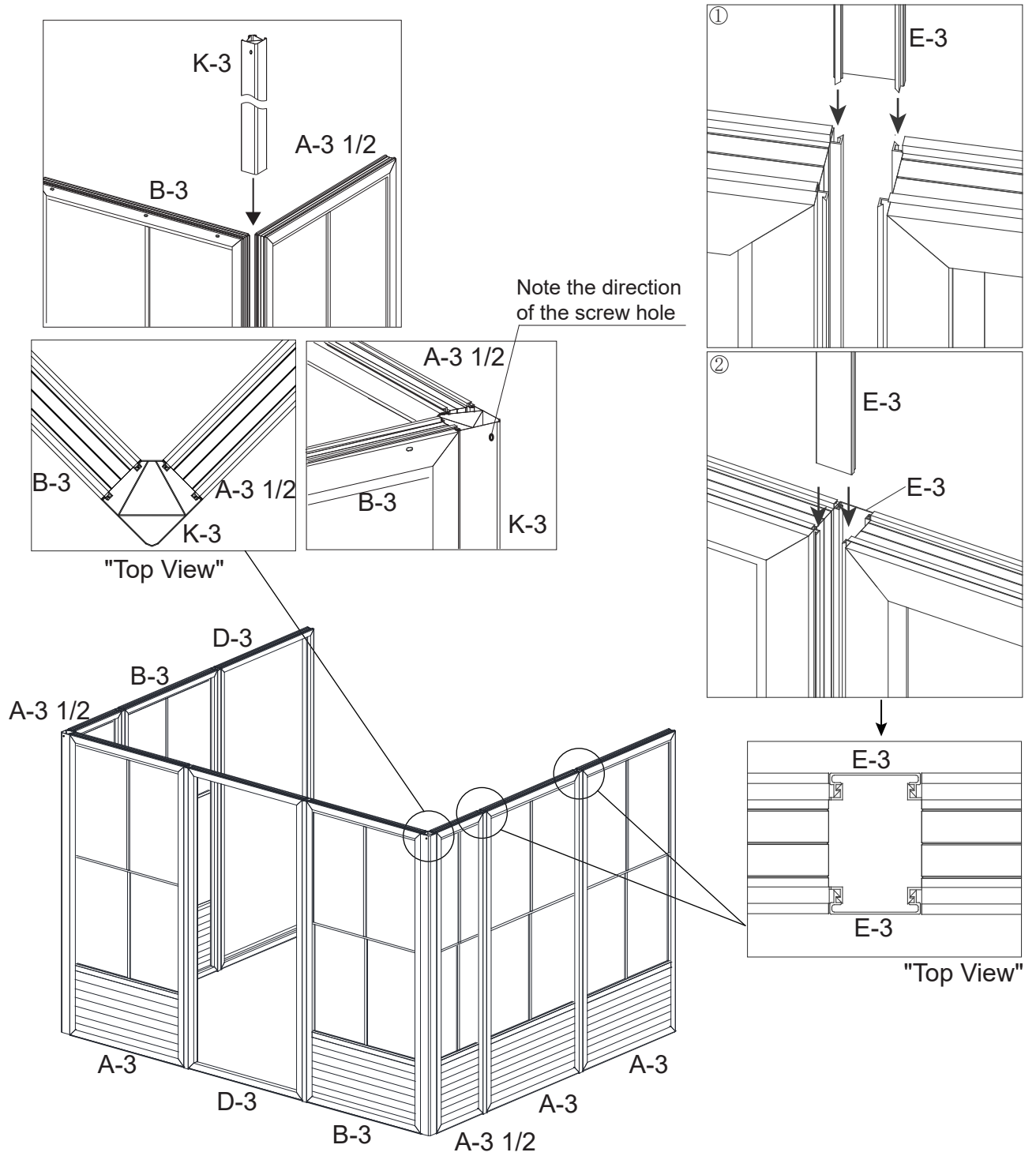

3. Connect the remaining Regular Frame (A-3) and Frame (A-3 1/2) with Corner Connector (K-3) and Connecting Piece (E-3) connected together, Corner Connector (K-3) with bolt holes facing up and out. (See sketch on page 8)

**STEP #4**

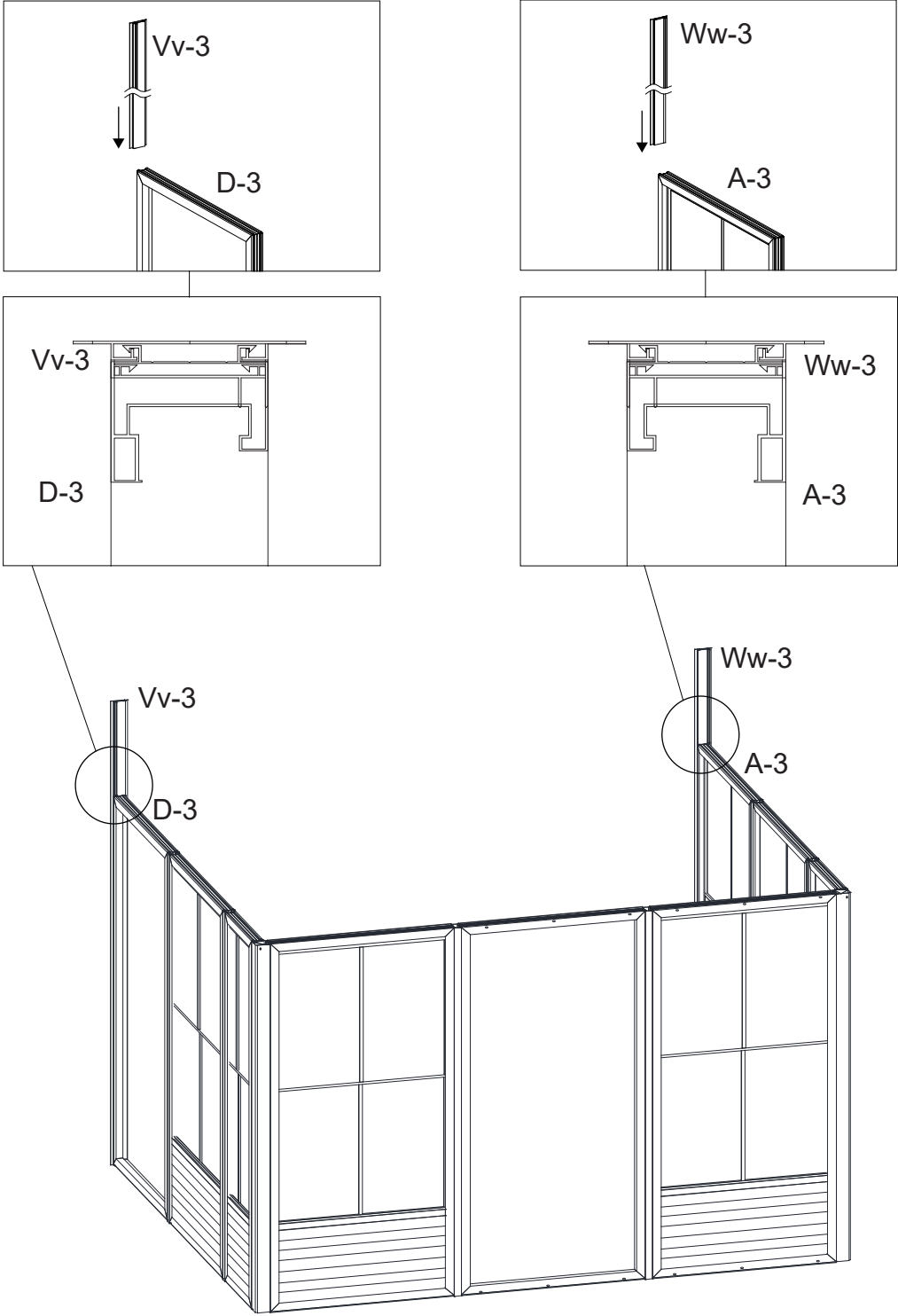

4. Slide the Left Wall Guide (Vv-3) and Right Wall Guide (Ww-3) into the 2 ends of the frames along the grooves, shaking while sliding for easier movement.

Note: Channel Grooves should remain to the outside on both (Vv-3) and (Ww-3).

**STEP #5**

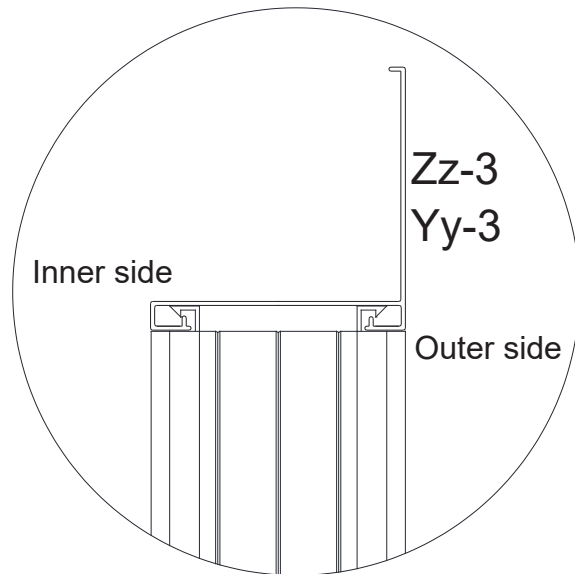
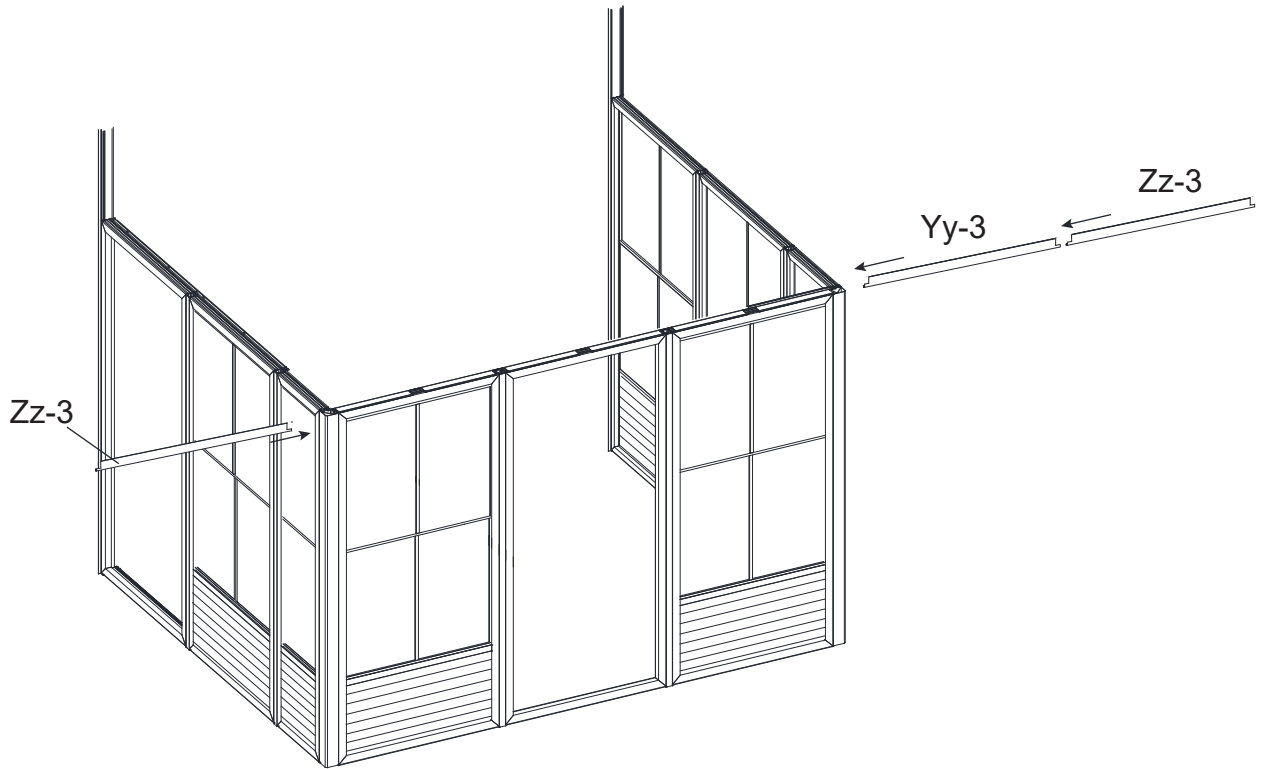

5. Insert Both Side wind shield (Zz-3) and the Middle wind shield (Yy-3) into the door along the track.  
Note: The direction of the wind shield.

**STEP #6**

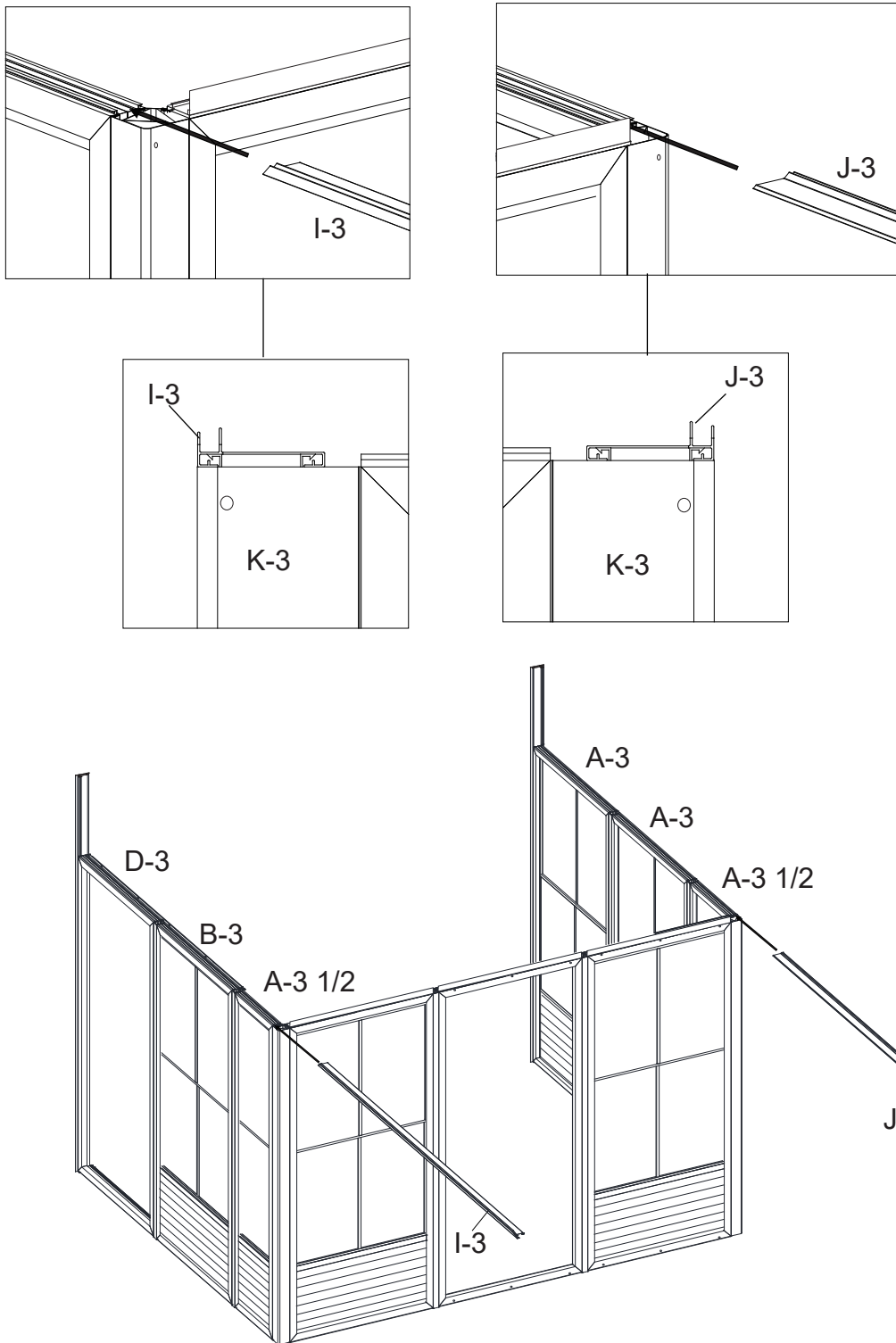

6. Insert the Left Side Receiver (I-3) and Right Side Receiver (J-3) at the top of the frame. Make sure the 2 frames are at the correct level, if not, use shims to compensate. Do not use tools to force.

## STEP #7

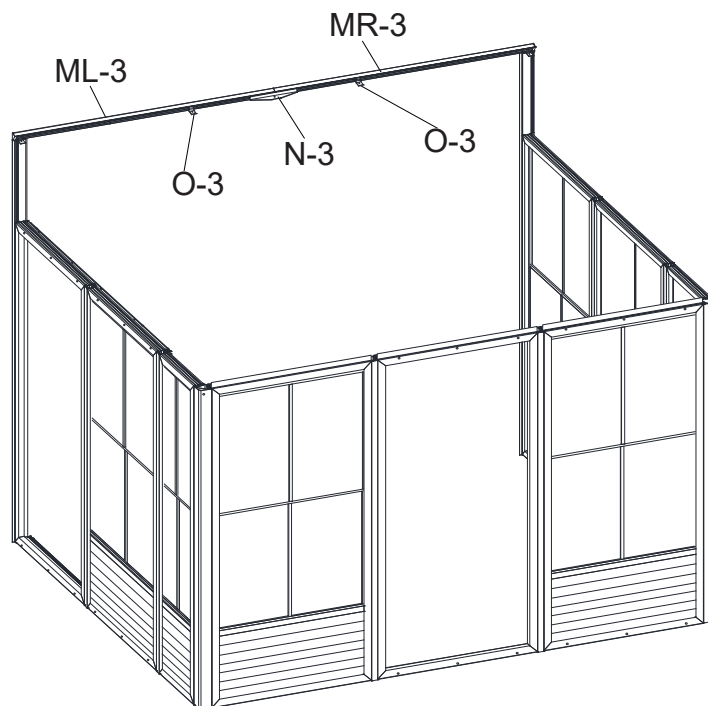
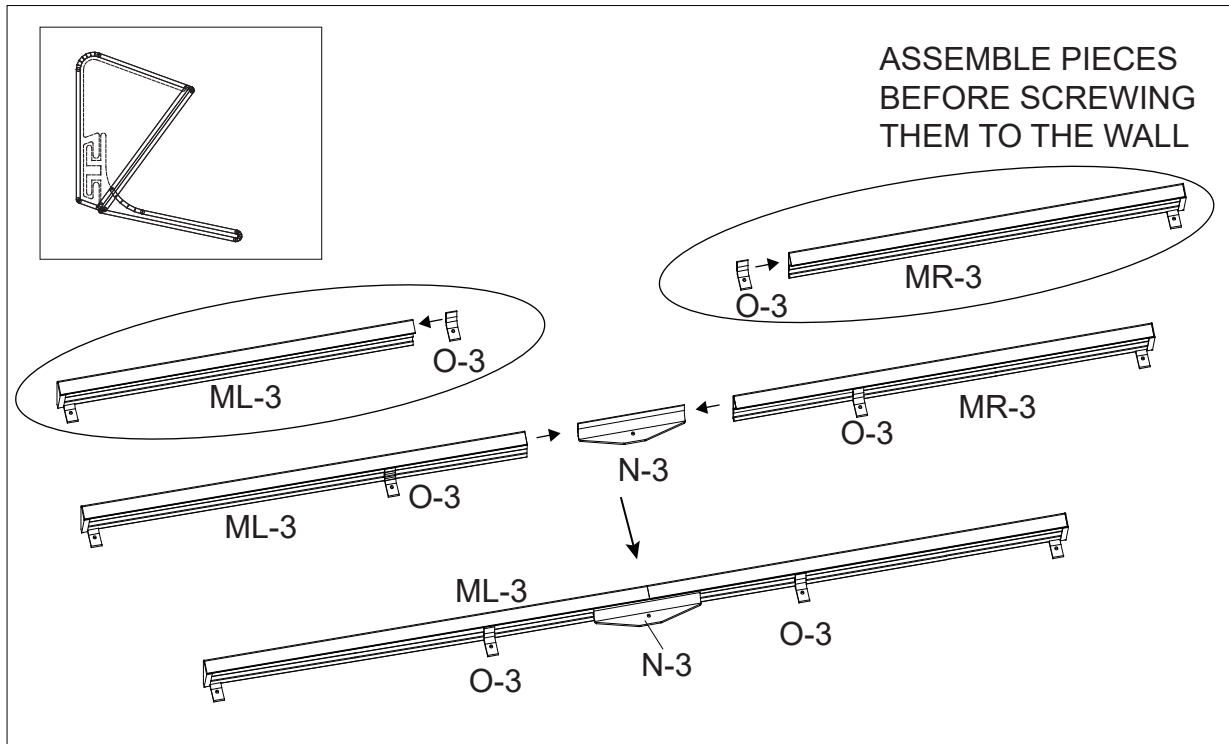

7.1 Assemble ML-3, N-3, O-3, and MR-3 as shown and position evenly above vertical guides, at 97" from the ground. Secure wall track and vertical tracks to brick or cement wall by drilling through the aluminum, at intervals of 16" (minimum) and using screws Xx-3. Or other fasteners according to wall material (Not Supplied).

**NOTE:** Once the wall track is in place, apply silicon along the top of the wall track and at the joint of the two vertical tracks.

**Silicone is not supplied.**

## **STEP #8**

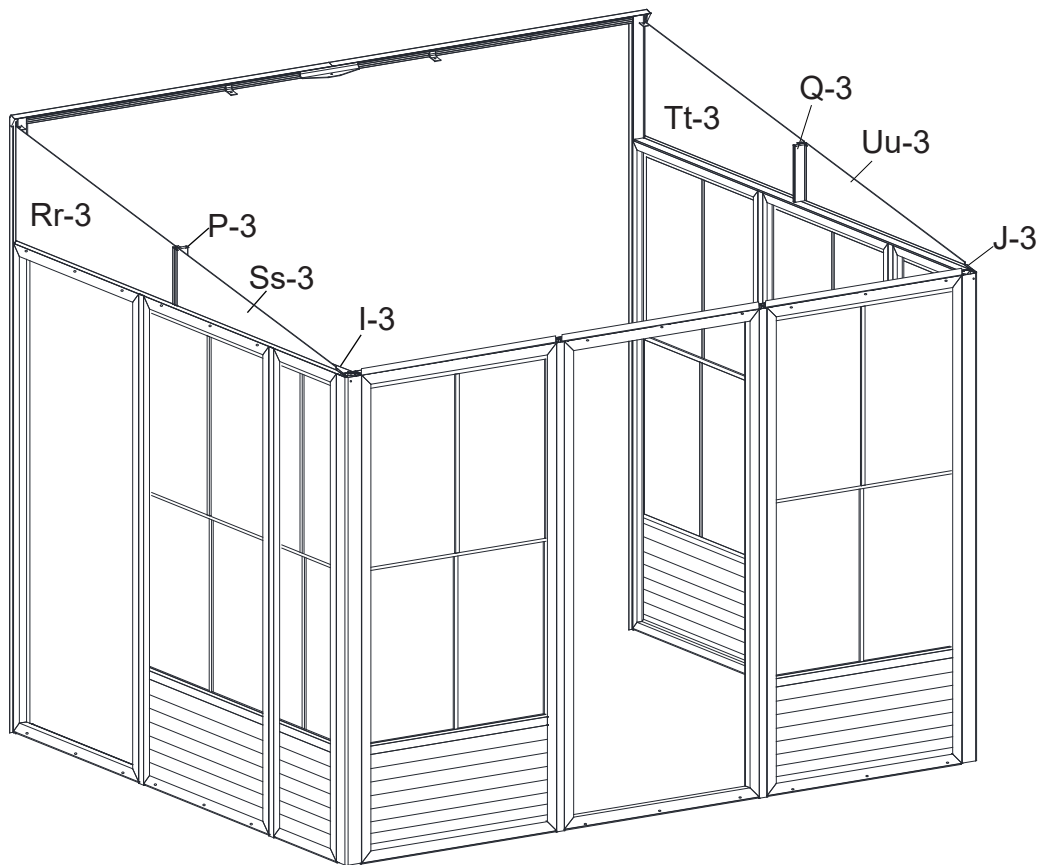
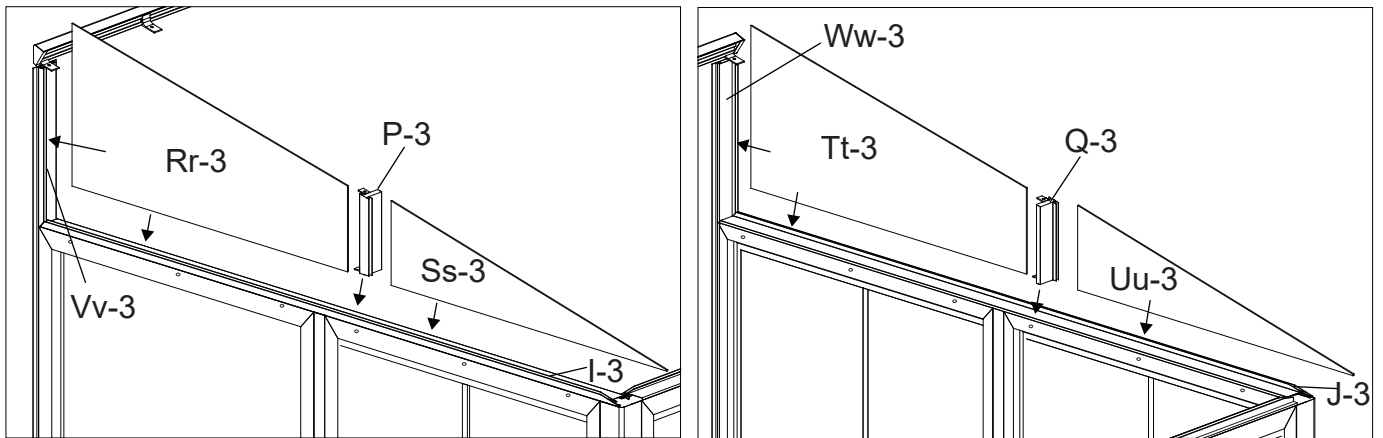

8. Set polycarbonate exposed side on the outside over horizontal left Side Receiver (I-3), use one Left Back Gable panel (Rr-3), one Left Gable Joint (P-3) and one Left Front Gable panel (Ss-3) , then do the right side with one Right Back Gable panel (Tt-3), one Right Gable Joint (Q-3) and one Right Front Gable panel (Uu-3) over the Right Side Receiver (J-3) horizontal panel.

**STEP #9**

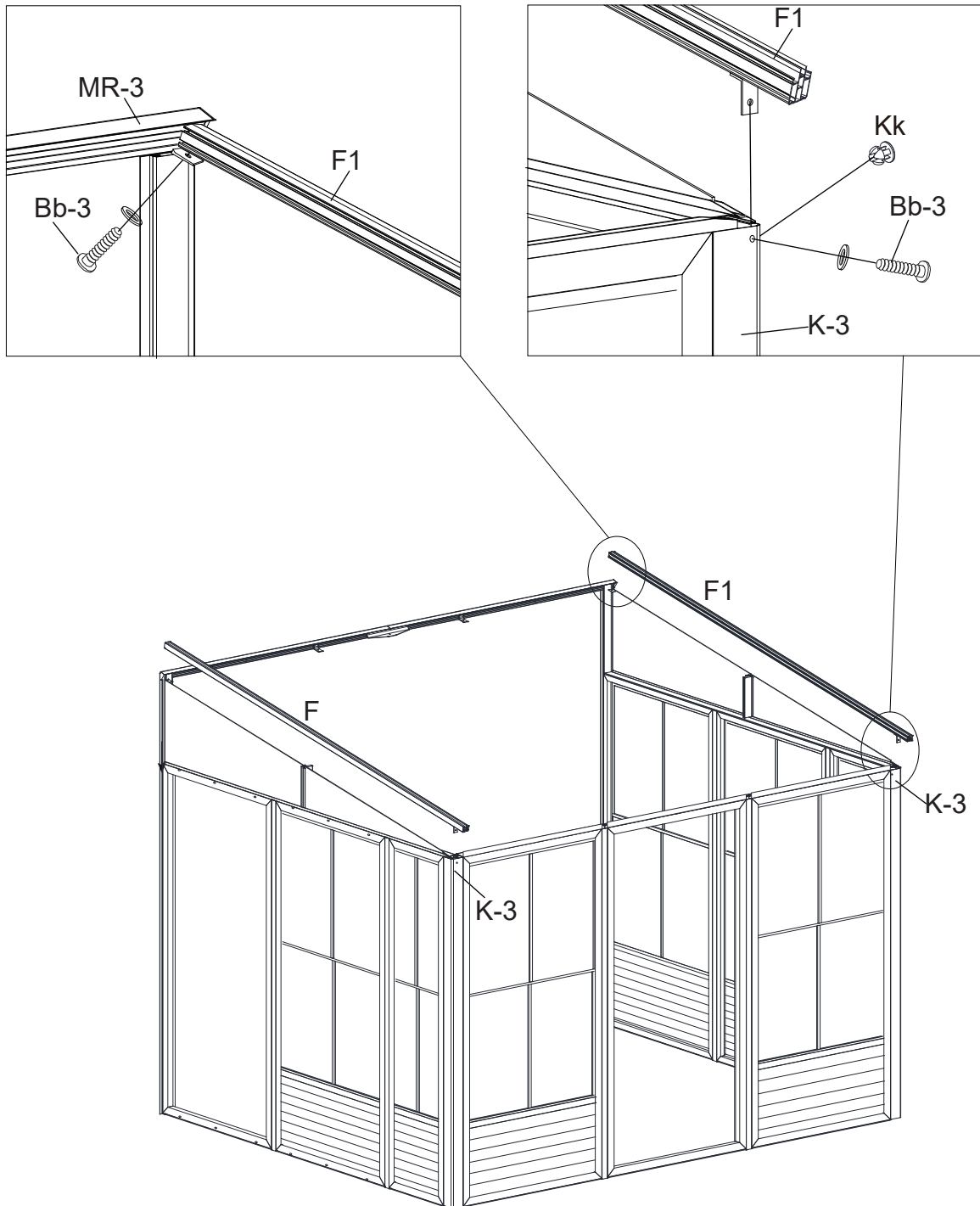

9. Set Right Side Rafter (F1) over the last bracket then secure to Corner Connector (K-3) and to Right Gable Joint (Q-3), bracket with screw (Bb-3). Repeat on the left side with Left Side Rafter (F) and to the left Gable Joint (P-3).

**STEP #10**

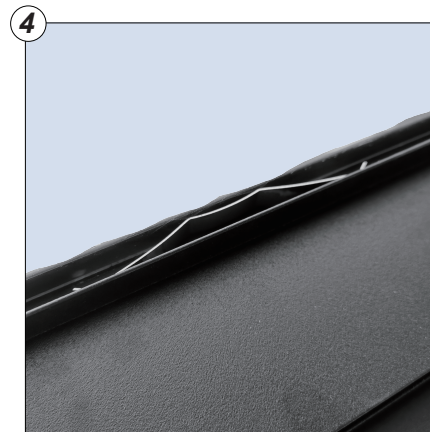
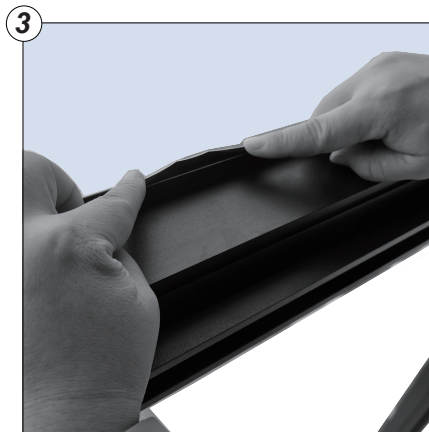
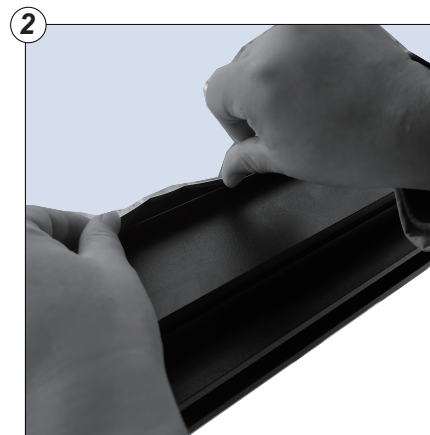
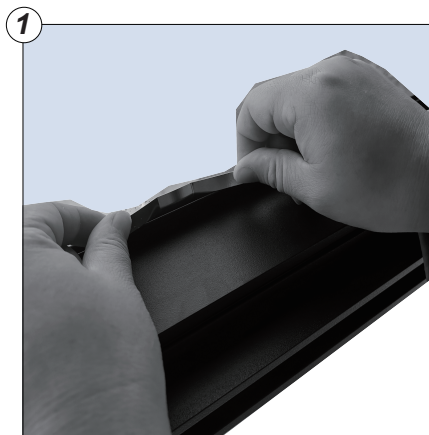
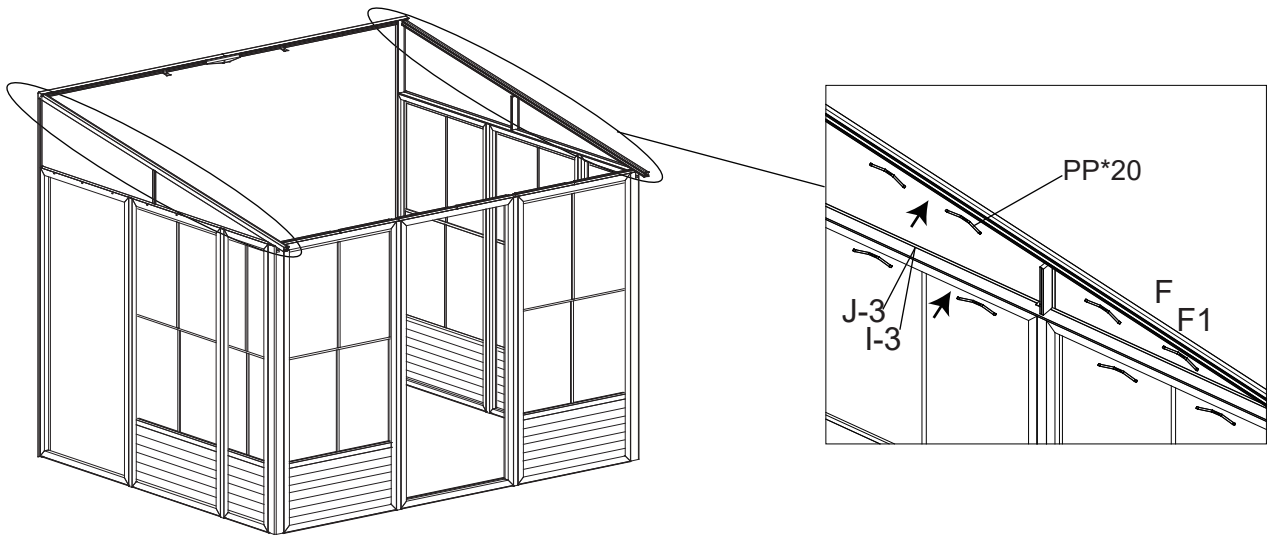

10. Install the Spring leaf (PP) into the inner groove of the Siderafter (F/F1) and Side Receiver (I-3/J-3). It is used to hold the Solid Panel in place.

## STEP #11

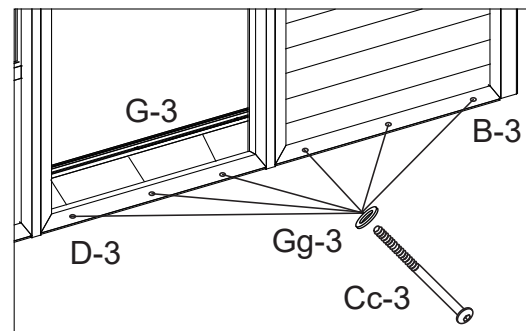
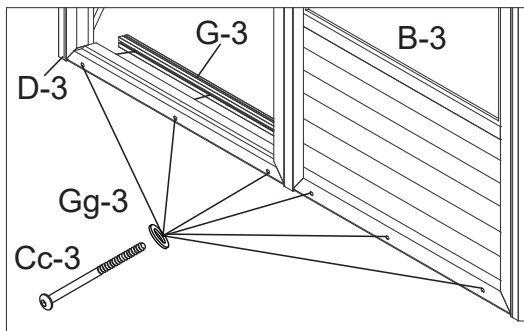
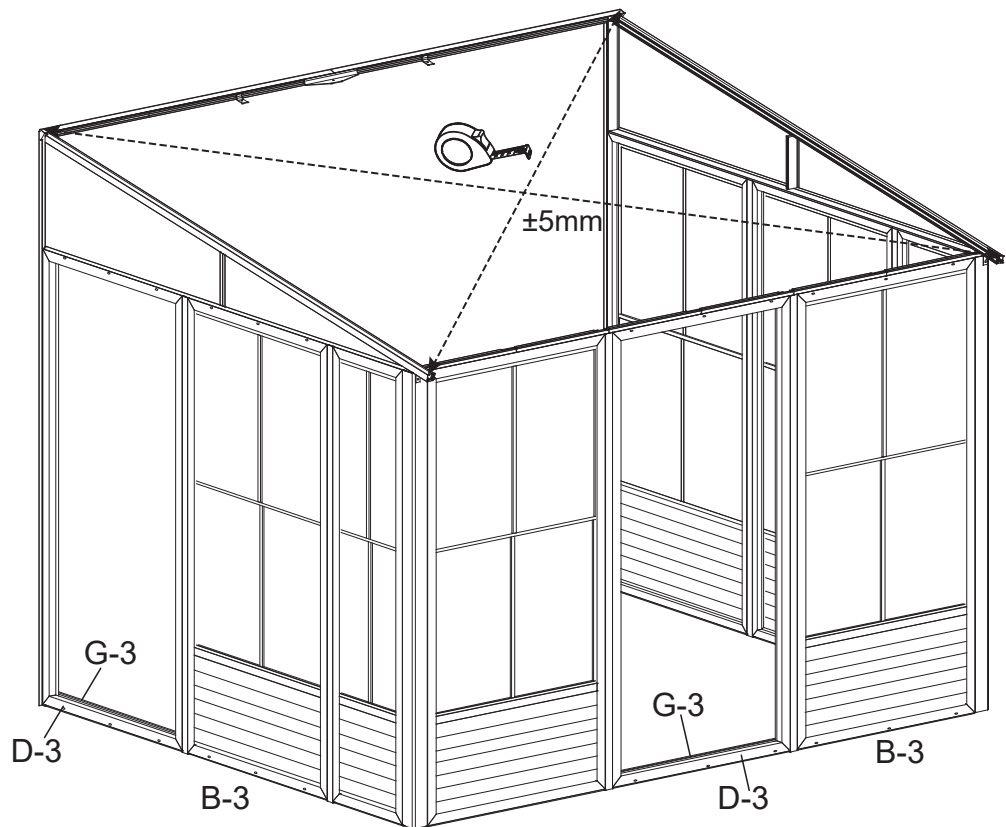

11. Attach the Sliding Door Frame (D-3), Frame Next To Door (B-3) and Bottom Door Rail (G-3) together with Bolts (Cc-3) and Washers (Gg-3).

**NOTE:** Be sure measurements diagonally across the overall frame are within 5mm of the same distance after completing this step

**STEP #12**

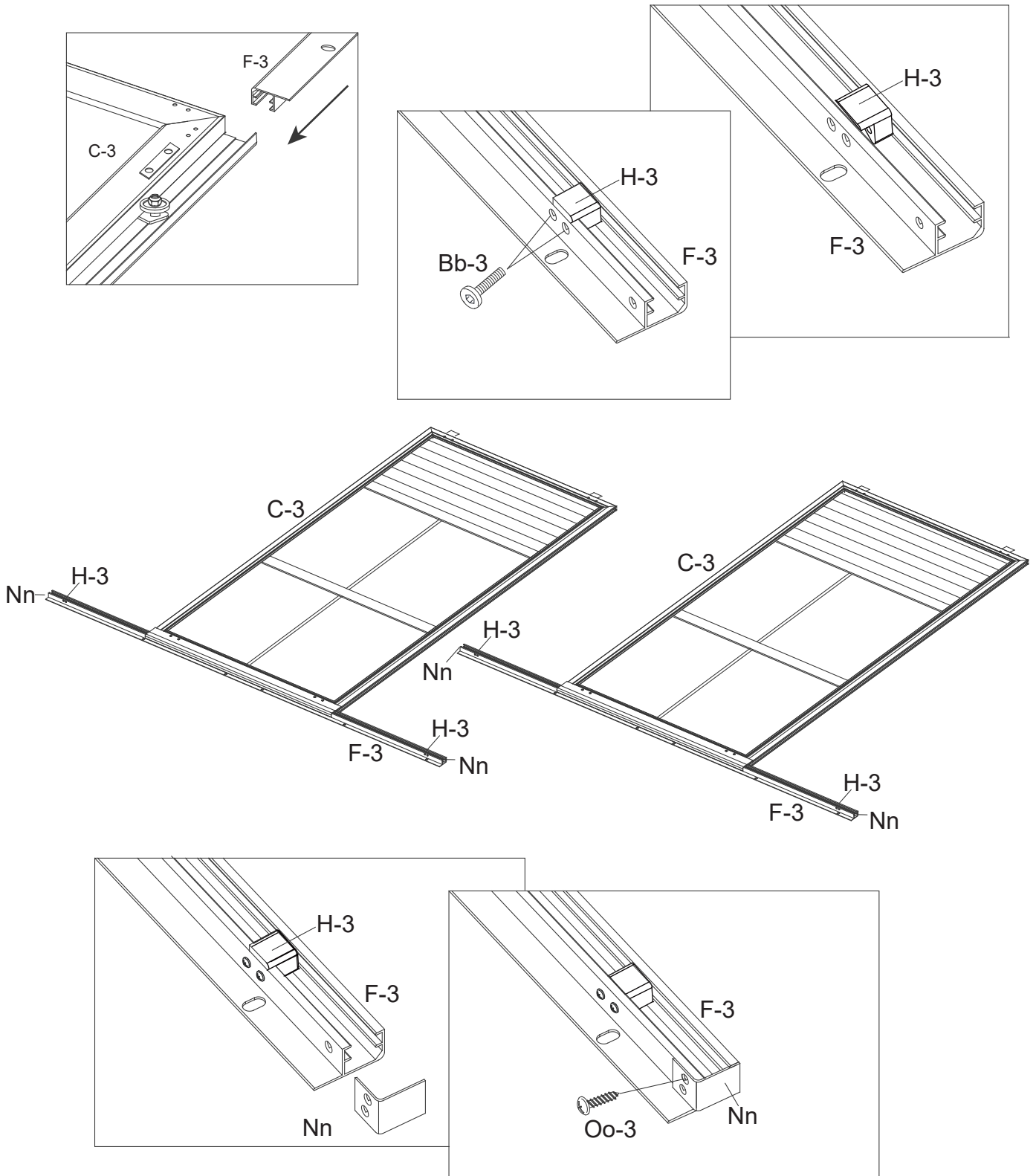

- 12.1 Insert the Top Door Rail (F-3) into the connect piece on the top of the Sliding Door (C-3).
- 12.2 Fix the Plastic Stopper (H-3) onto the both ends of the Top Door Rail (F-3) by using the Bolts (Bb-3).
- 11.3 Fix the Upper Door Rail End (Nn) onto the both ends of the Top Door Rail (F-3) by using the Bolts (Oo-3).

**STEP #13**

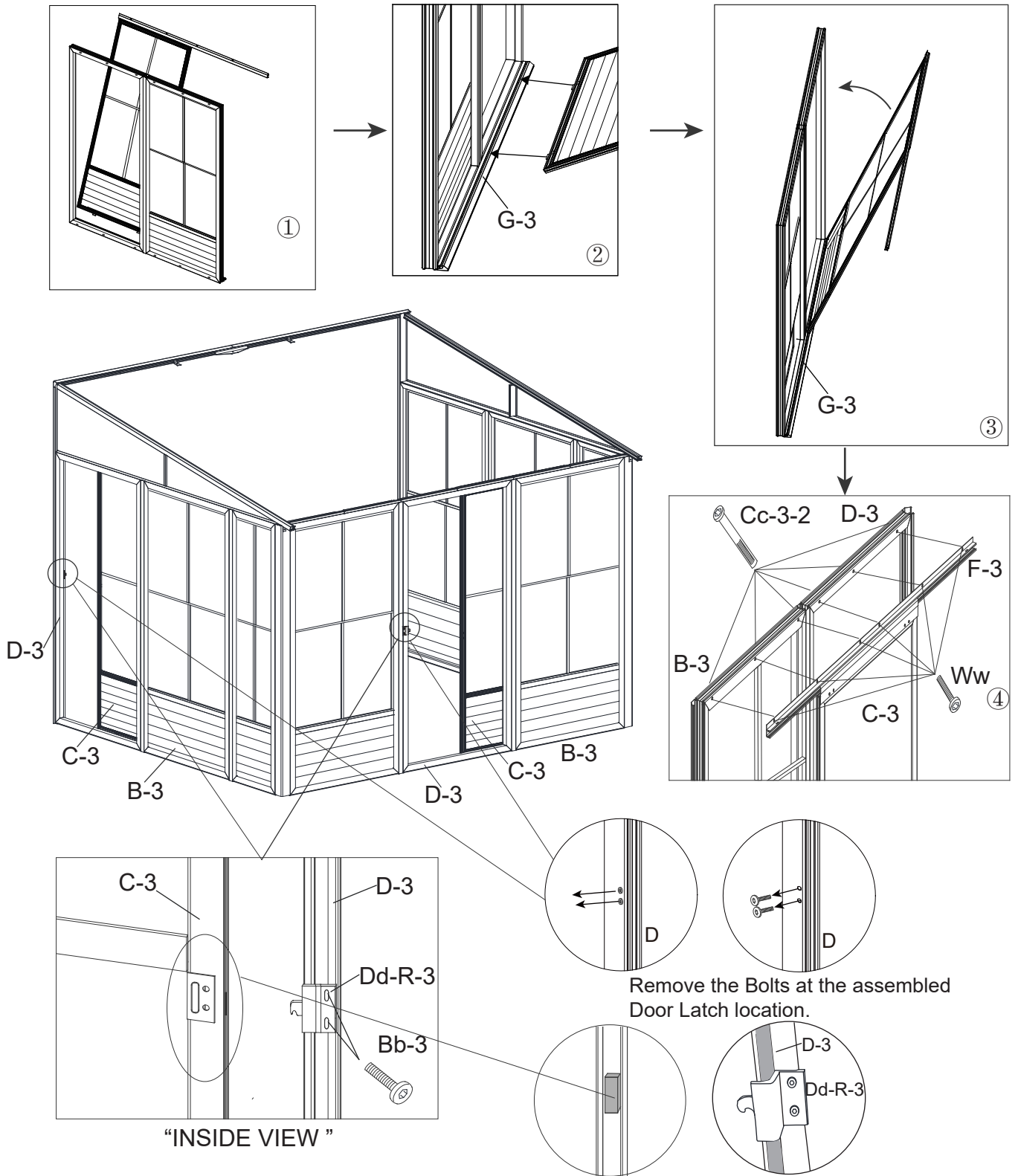

“INSIDE VIEW”

Remove the Bolts at the assembled Door Latch location.

Remove the small square here and you can use it.

- 13.1 Put the assembled Sliding Door (C-3) upright, insert the lower end into the Bottom Door Rail (G-3), and fix the upper end with Bolts (Cc-3- 2/Ww).Make sure to push up the upper door track (F-3) so that the doors does not rub against the bottom track.
- 13.2 Fix the Right Door Latch (Dd-R-3) with the Sliding Door Frame by using the Bolts (Bb-3).

## **STEP #14**

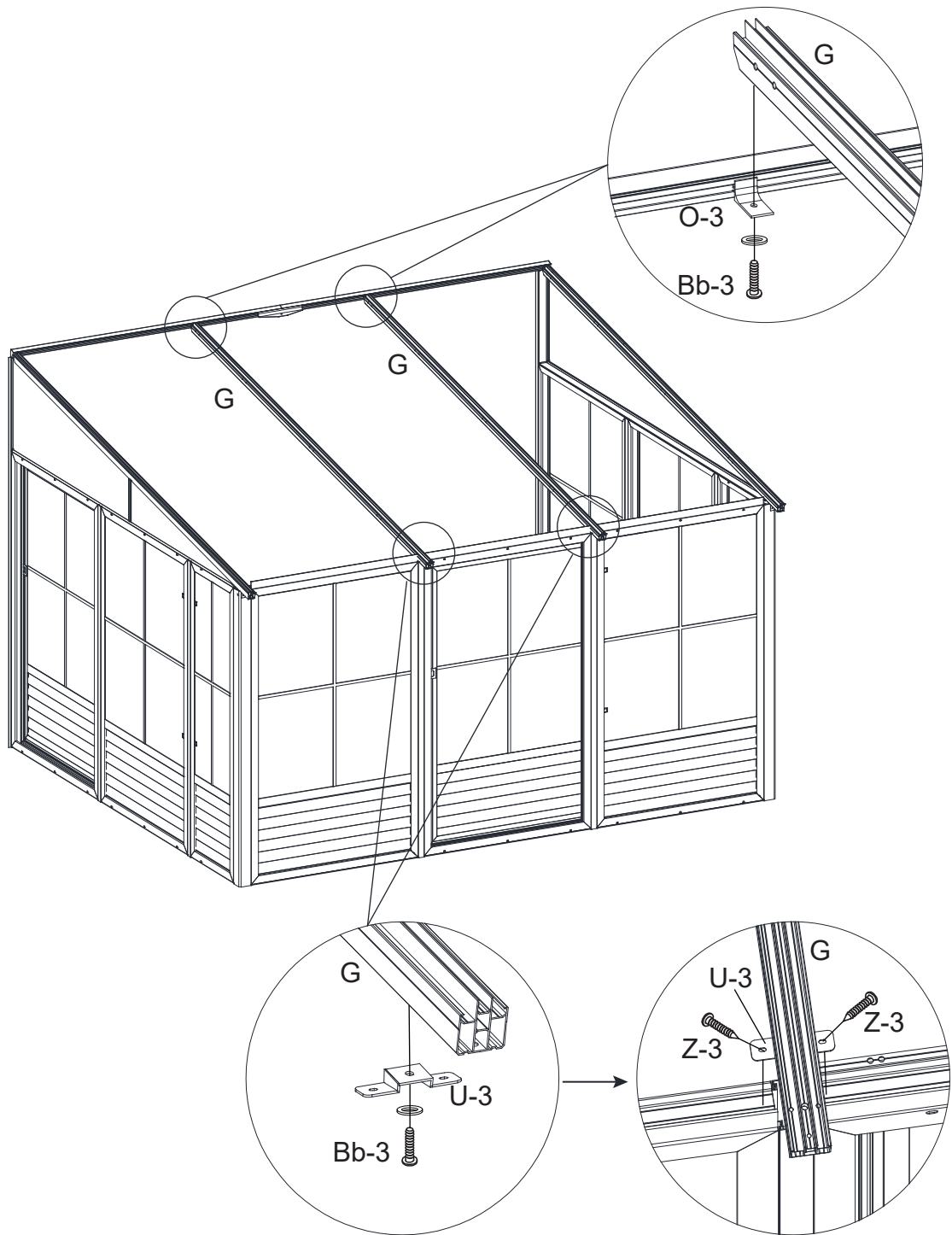

14. Attach the Mounting Bracket (U-3) and the Regular Roof Bar (G) together using the Bolts (Bb-3), ( Hand Tighten. DO not use power drill.). The upper end of the Regular Roof Bar (G) is then attached to the Rafter Bracket (O-3) using Bolts (Bb-3), (hand tighten, DO not use power drill.) The lower end of the Regular Roof Bar (G) is secured between each panel using Bolts (Z-3).

## STEP #15

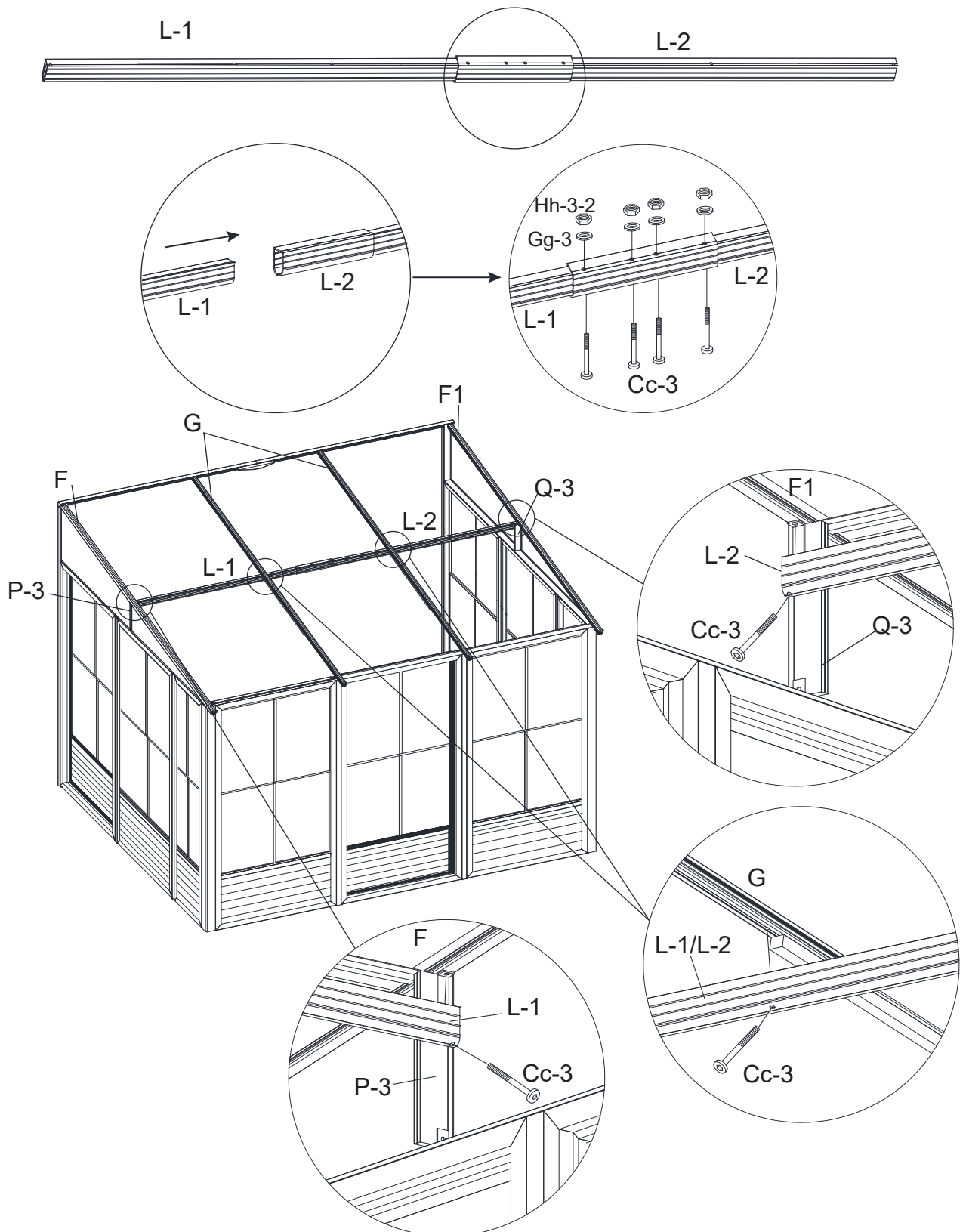

- 15.1 .Use Bolt (Cc-3) and Nut (Hh-3-2) to assemble Crossbeam L-1 and Crossbeam L-2 together.
- 15.2. Attach the assembled Crossbeam (L-1) and Crossbeam (L-2) to the Left side rafter (F) and Right side rafter (F1) through Gable Joint (P-3) and Gable Joint (Q-3), connect the middle to the Regular rafter(U-3),and fix them with Bolt (Cc-3).Tighten the Bolts manually.

**STEP #16**

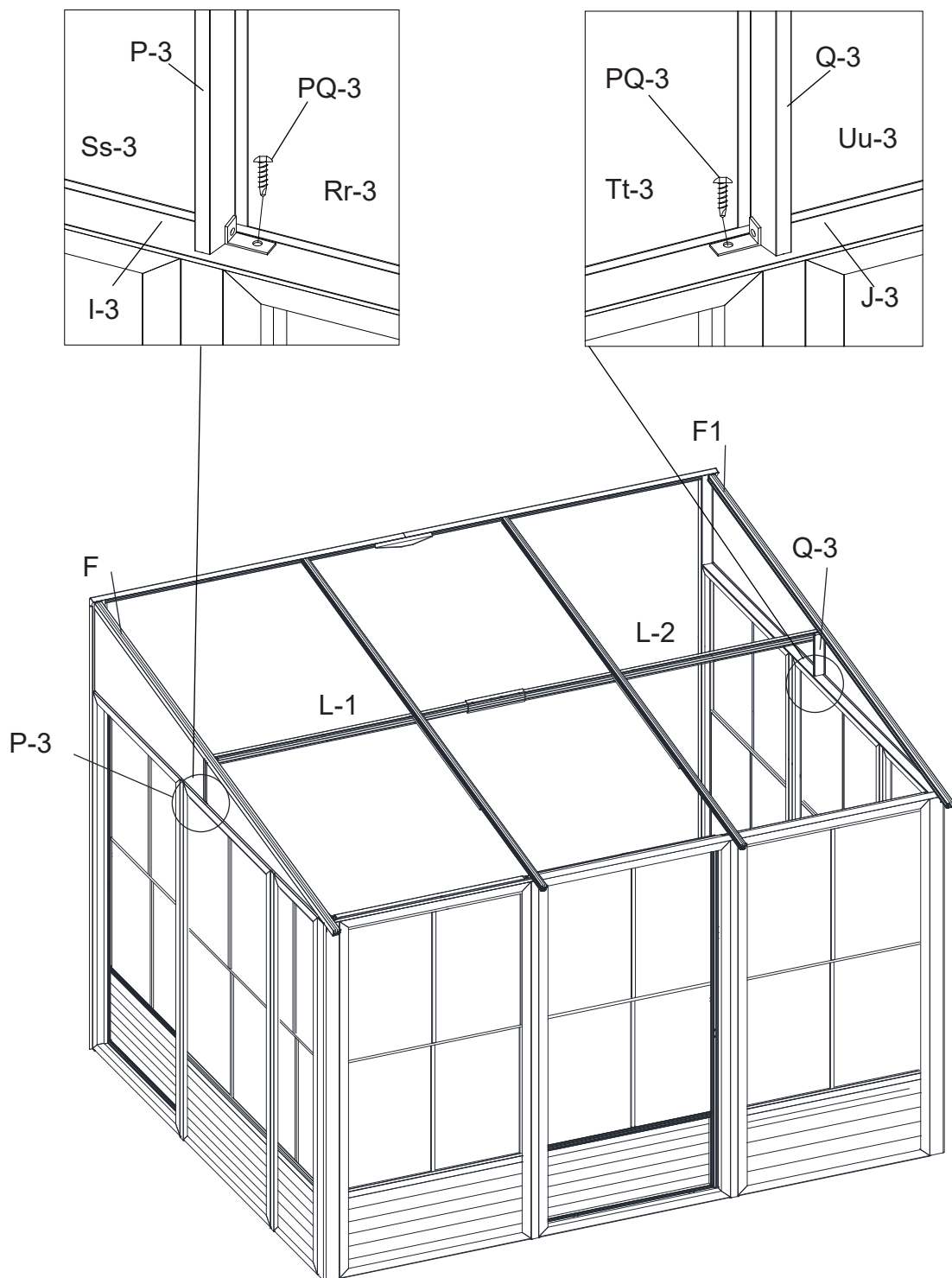

16. Secure Gable Joint (P-3) and (Q-3) to Side Receiver (I-3) and (J-3) respectively with self-tapping Screws (PQ-3).

**STEP #17**

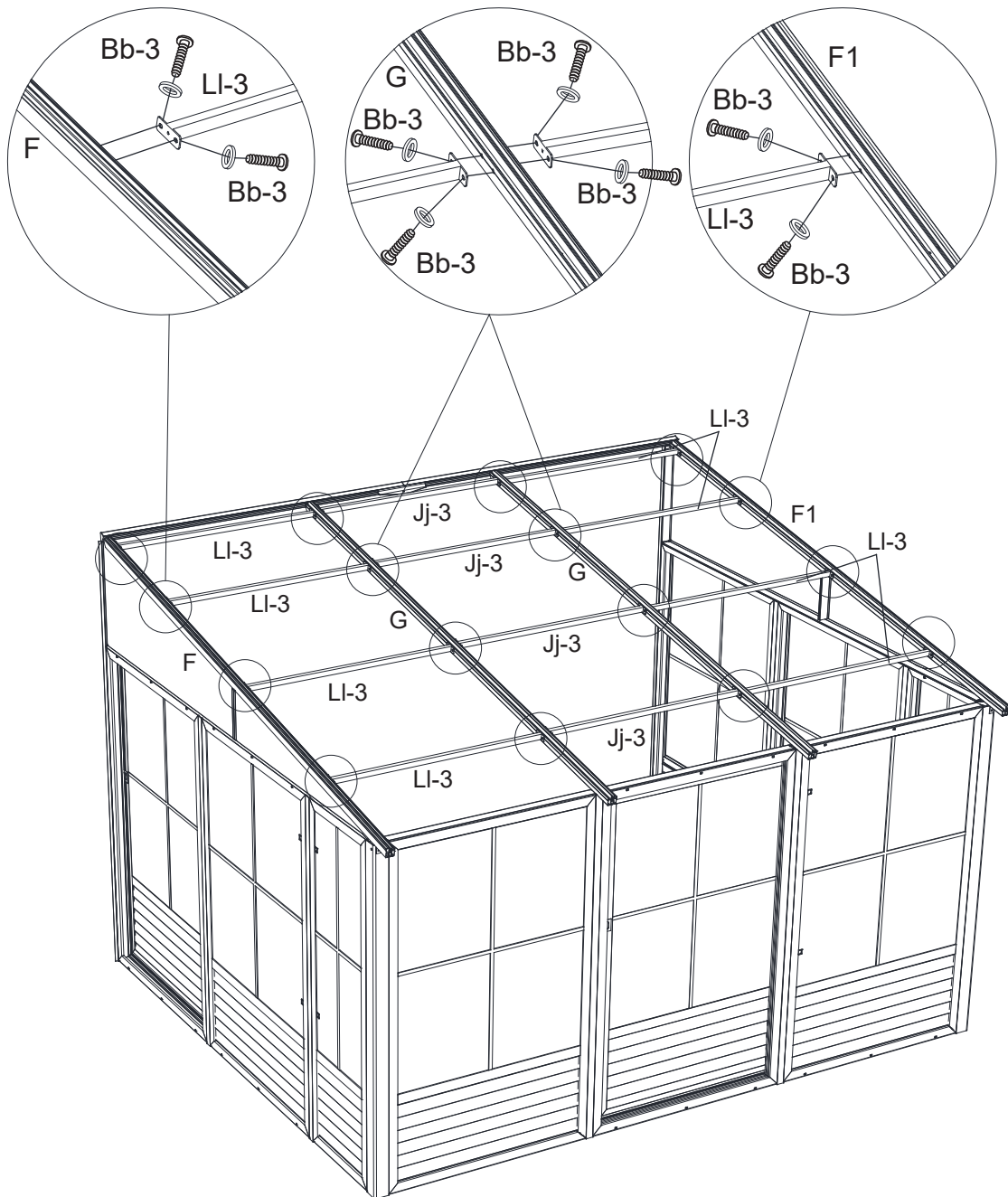

17. Connect the Both side Supported tube (LI-3) and Middle Supported tube (Jj-3) to the Rafters (F/F1/G) and fix them with Bolts (Bb-3) and Washers (Gg-3) respectively.

**STEP #18**

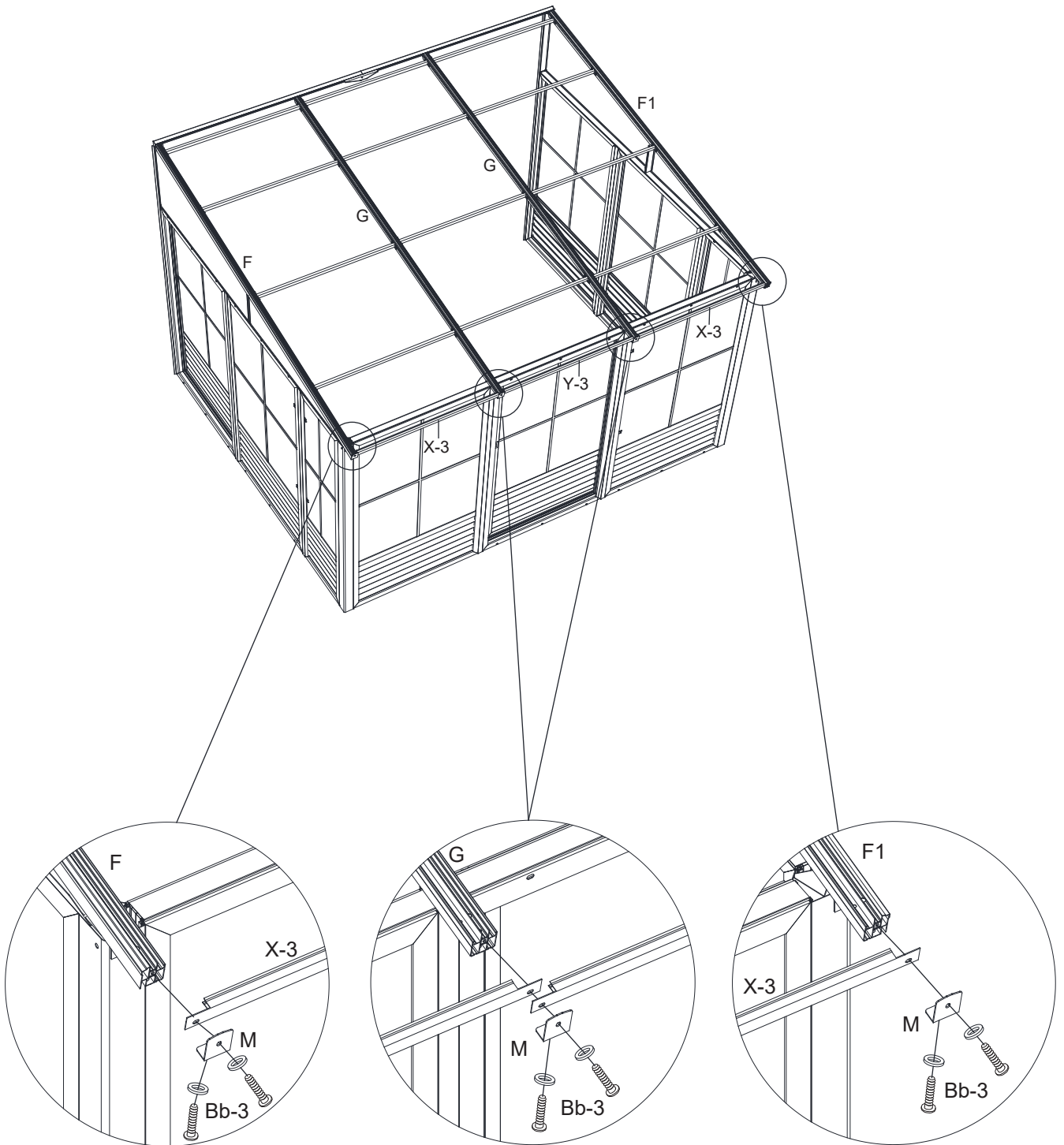

18. Attach the Top beam seal (M), the Sealing (X-3/Y-3) and Rafters (F/F1/G) together separately and fix them with Bolts (Bb-3) and Washers (Gg-3).

**STEP #19**

Please note: The Roof Panels are built up between each other as shown in the picture.

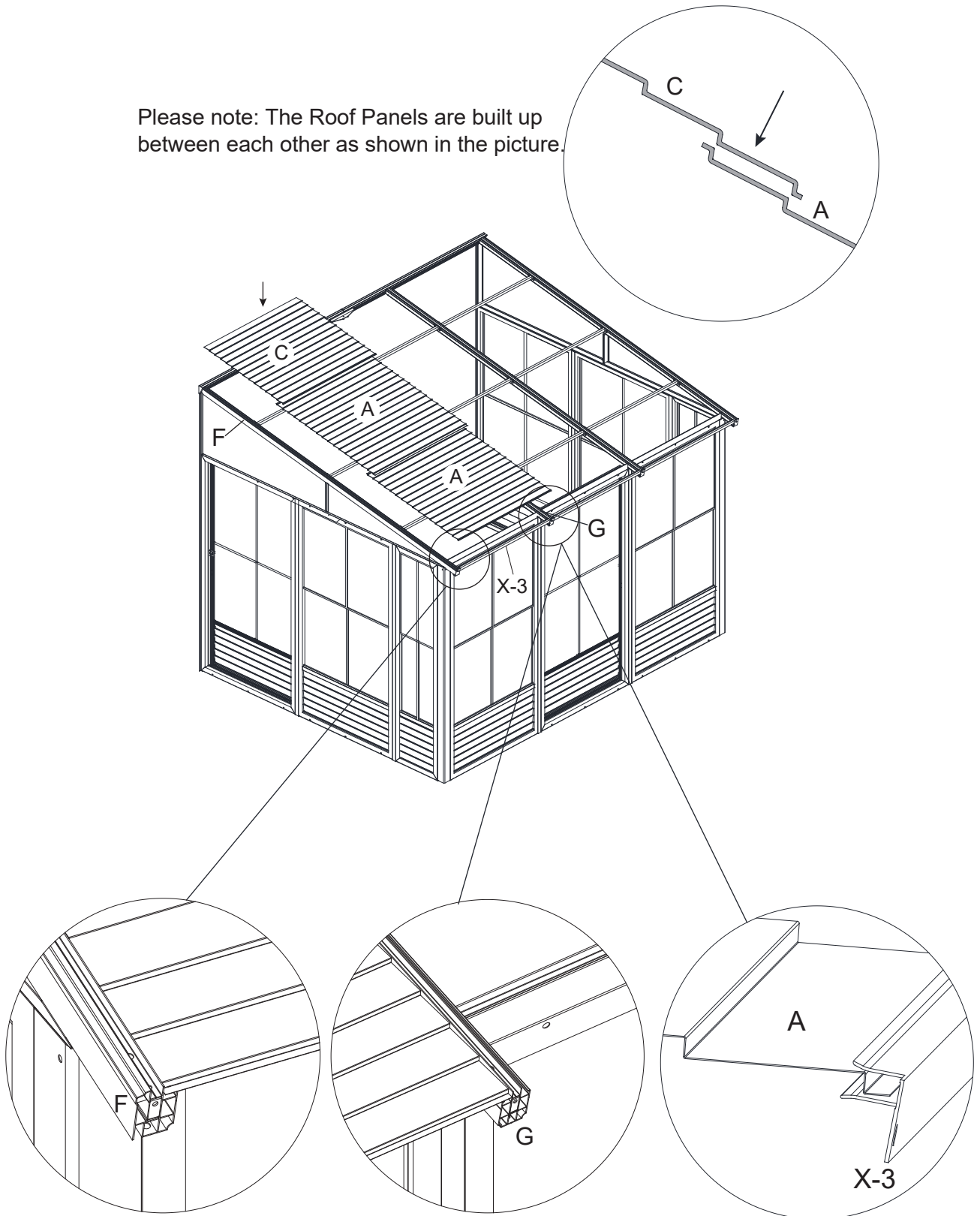

19. Attach Slide Roof Panels (A/C) to Rafters (F, G) in order.

**STEP #20**

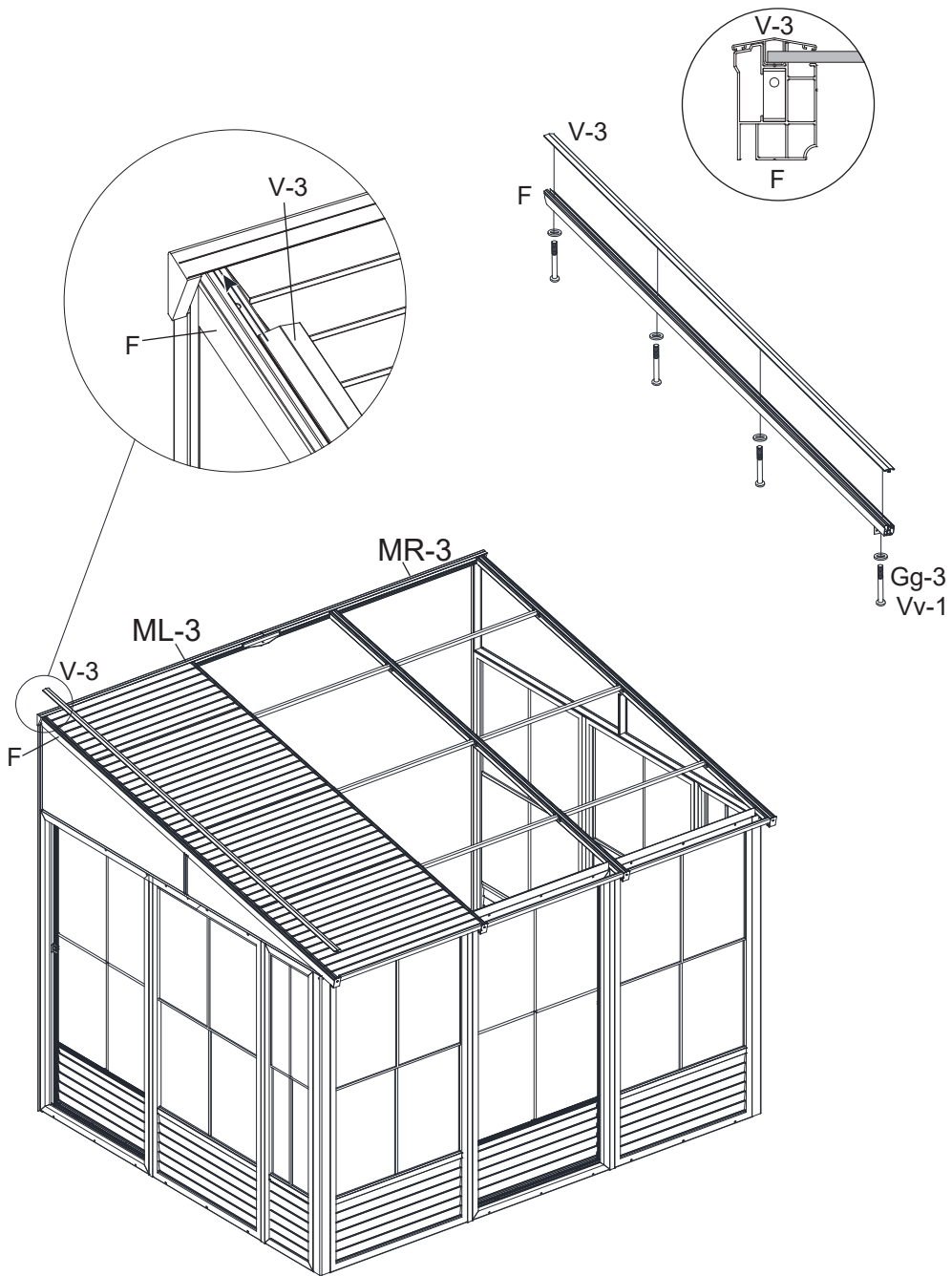

20. Attach the Roof bar Pressboard (V-3) by inserting one end into the Wall Track (ML-3) and connecting it to the Rafters (F), securing it with Bolts (Vv-1) and Washers (Gg-3)

## STEP #21

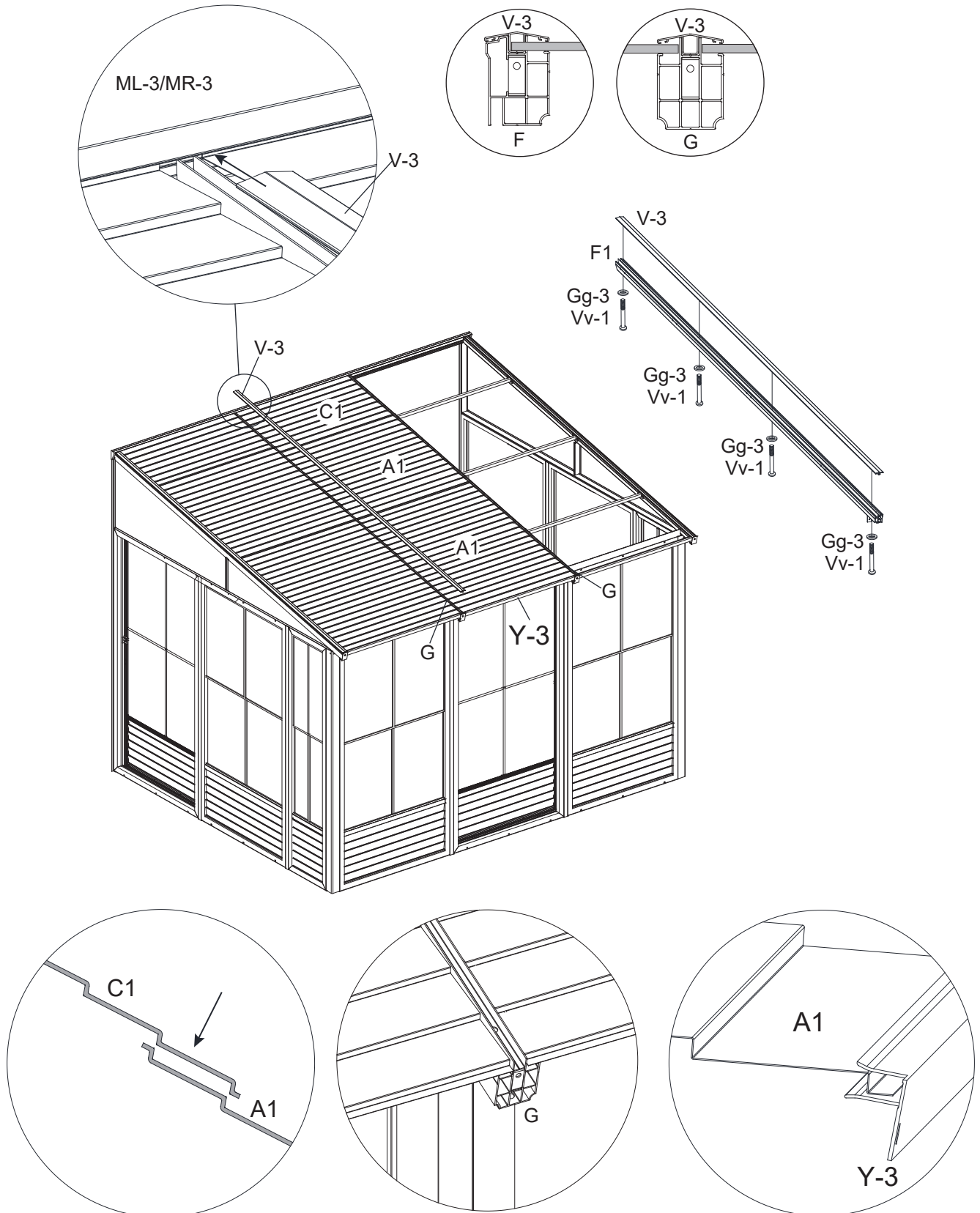

Please note: The Roof Panels are built up between each other as shown in the picture.

21.1. Attach Slide Roof Panels (A1/C1) to Rafters (G) in order.

21.2. Attach the Roof bar Pressboard (V-3) by inserting one end into the Wall Track (ML-3) and connecting it to the Rafters (G), securing it with Bolts (Vv-1) and Washers (Gg-3).

## STEP #22

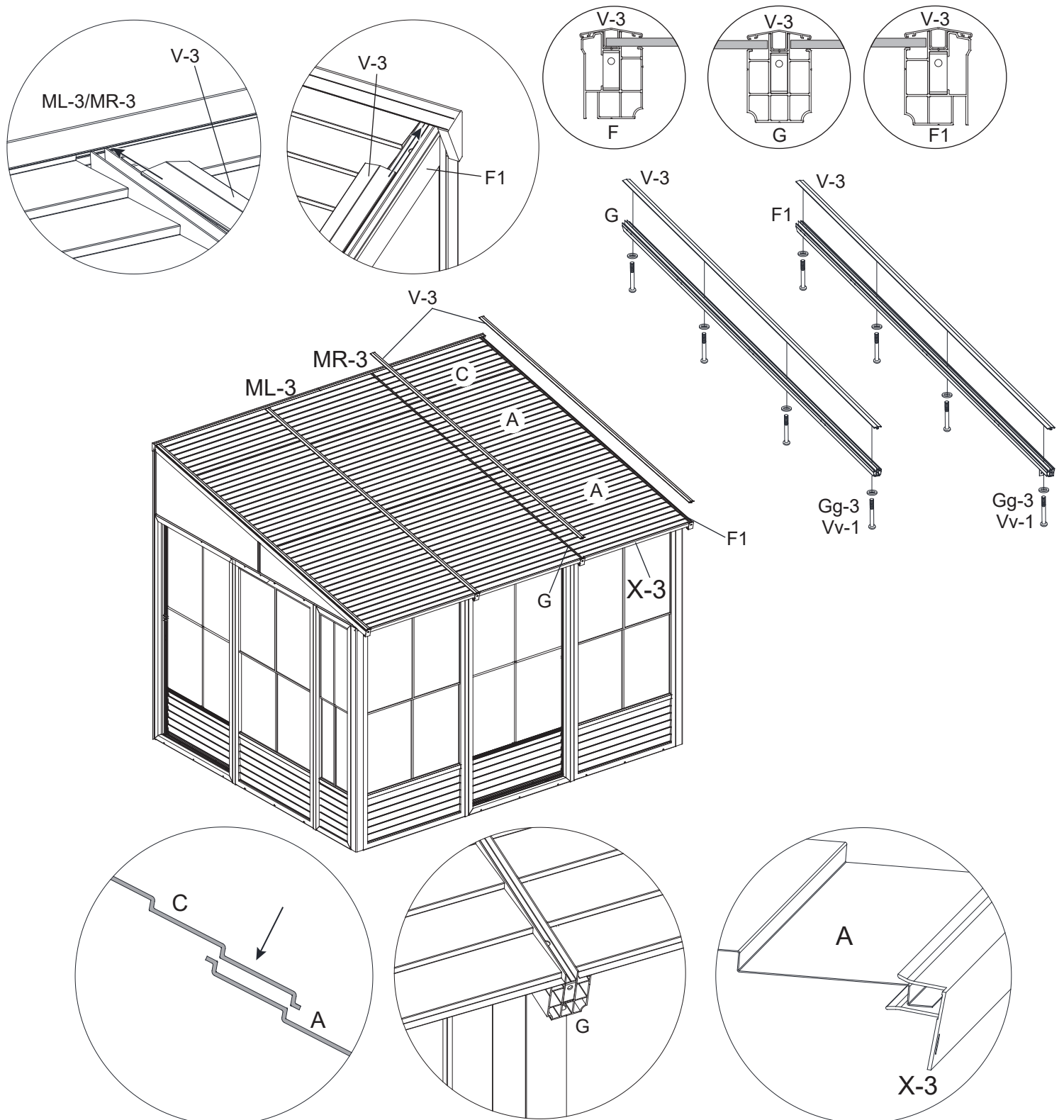

Please note: The Roof Panels are built up between each other as shown in the picture.

22.1. Attach Slide Roof Panels (A/C) to Rafters (G/F1) in order.

22.2. Attach the Roof bar Pressboard (V-3) by inserting one end into the Wall Track (MR-3) and connecting it to the Rafters (G), securing it with Bolts (Vv-1) and Washers (Gg-3).

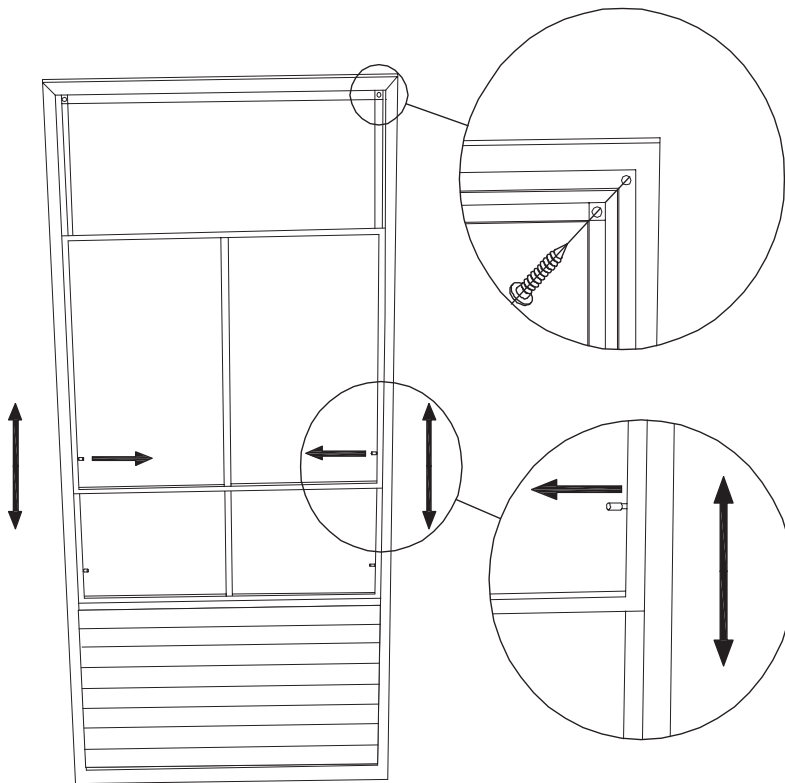

**SPECIAL NOTES:**

To remove a screen, remove the two (2) screws at the top of the frame then pull sideways to the opposite end of the handle to remove. To remove wind panels, push or pull to one side, making sure the locking pin is not locked the remove the panels gently.

**CLEANING INSTRUCTIONS:**

Use only mild or warm soapy water, no strong or abrasive cleaning products. Be sure to remove heavy snow or ice.

**WARNING:**

- 1) 1-Do not use a BBQ or any other flammable product inside the solarium.
- 2) **Remove snow from the roof.**

## **\*Suggestions**

The below mentioned are only suggestions in order to permit drainage, these will vary depending on your flooring – material, flatness and slope.

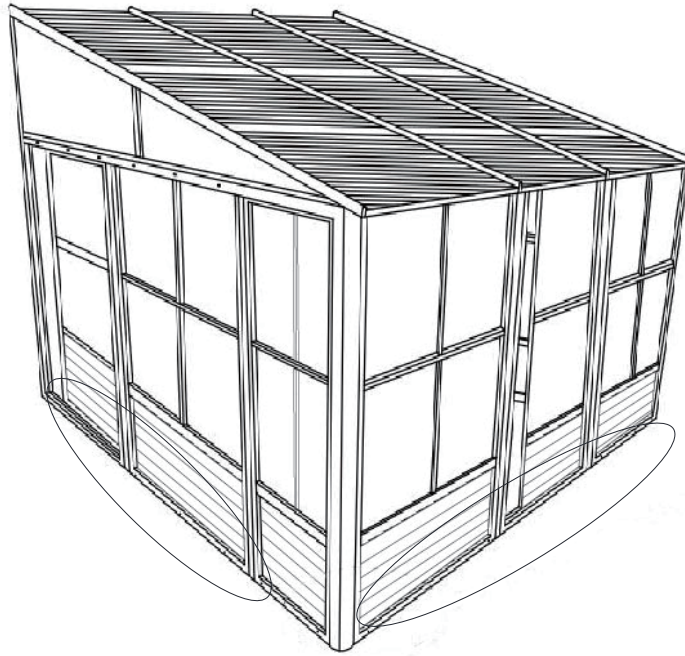

### **For Concrete Flooring**

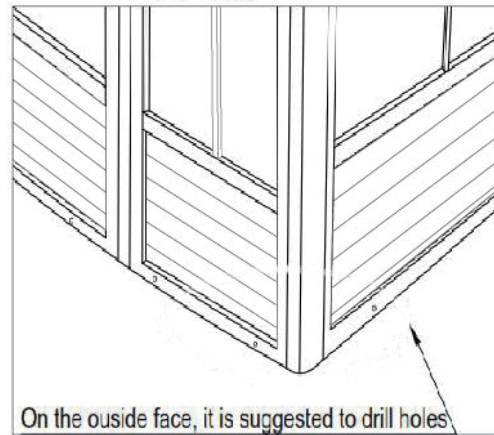

On the outside face, it is suggested to drill holes at the bottom end of the panels to permit drainage when installing on concrete floor

### **For Wooden Deck**

**Drill through the wooden deck where drain holes are located to permit drainage**

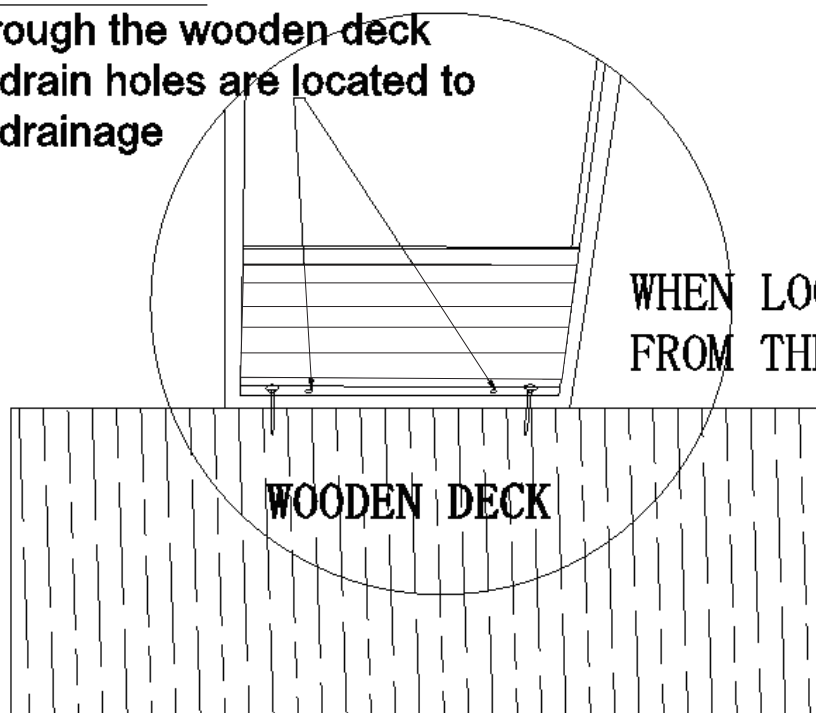

**WHEN LOOKING FROM THE INSIDE**

**WOODEN DECK**

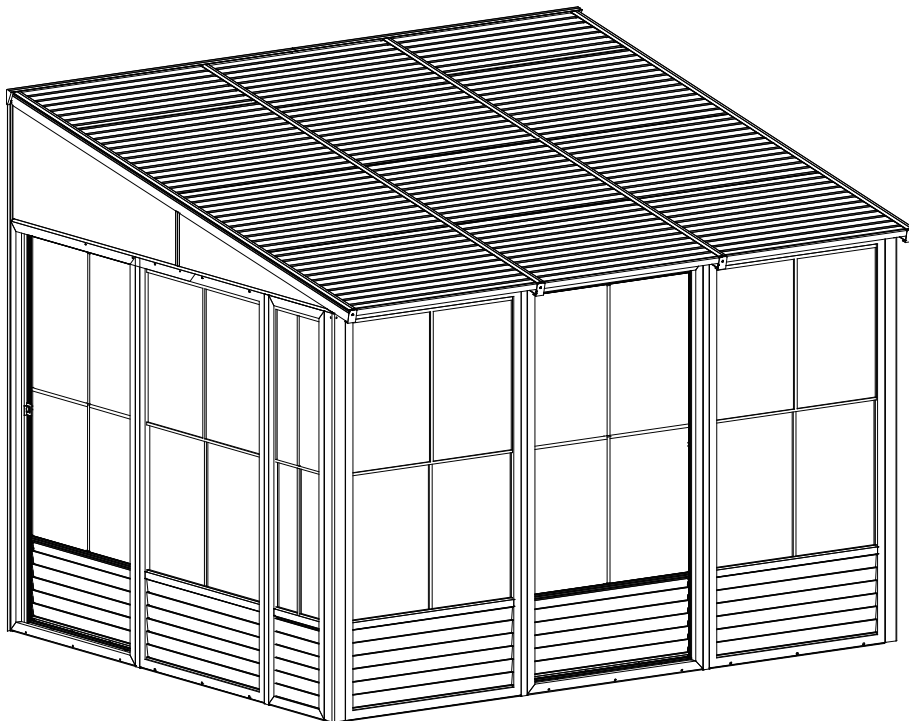
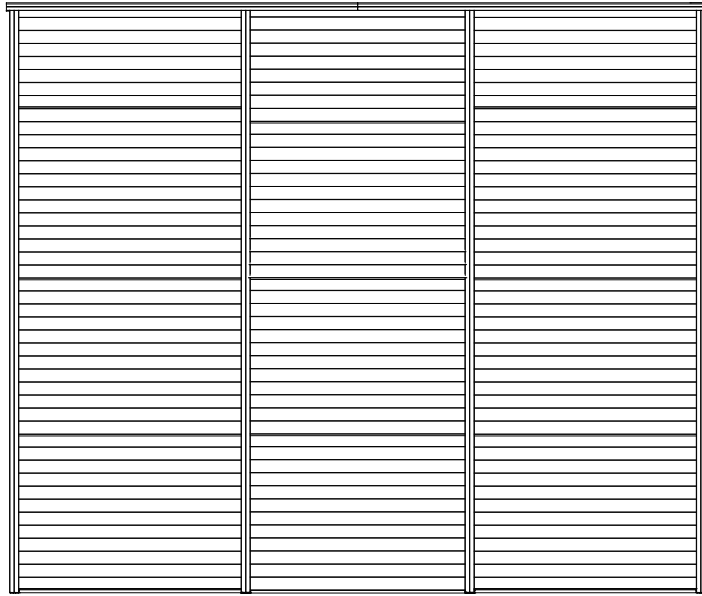

# WARRANTY

Carefully inspect the contents of the package to check if any components are missing or damaged. In the event that any parts are missing or damaged, **do not return the product to the place of purchase; instead, contact Gazebo Penguin's Customer Experience Department.**

**Montreal: (514) 276-3485**

**Elsewhere in Canada and the United States: 1-800-737-7174**

**info@gazebopenguin.com**

This product has been designed and manufactured to meet the highest standards of quality and durability. It is warranted against defects in material and/or workmanship as subjected in the «Warranty Limitations and exclusions» listed below:

- **1 YEAR ON MANUFACTURING DEFECTS**

In the event that the product is damaged or the warranty period has expired, please contact Gazebo Penguin's Customer Experience Department for a complete list of replacement parts and prices.

## WARRANTY LIMITATIONS AND EXCLUSIONS

- 1. Uncovered Damages:** This warranty does not cover damages caused by wind, falling objects, fire, animals, vegetation, vandalism, extreme weather conditions, or collapses due to the accumulation of snow and/or ice.
- 2. Roof Maintenance:** The roof must remain free of snow and ice accumulation. Such accumulation must be removed in five-foot (5') sections from right to left. Damages resulting from lack of roof maintenance are not covered under the warranty.
- 3. Snow and Ice Removal:** Removing snow or ice from inside the product is prohibited, as it may damage the product.
- 4. Positioning:** It is advised not to place the product near buildings or trees, as snow and/or ice may slide off and accumulate on the roof, causing excessive weight.
- 5. Installation:** The warranty is valid only if the product is installed according to the instructions provided by Gazebo Penguin. Improper installation, including inadequate anchoring, voids the warranty..
- 6. Water Infiltration:** Water infiltration may occur during heavy rains. Refer to the instruction manual for window positioning and information on water drainage.
- 7. Replacement Clause:** We reserve the right to repair or replace any defective product or part at our sole discretion.
- 8. Modifications:** Any modification or addition to the product voids the warranty.